

DOI DOI: <https://doi.org/10.24297/jam.v18i.8656>

New Schrödinger Wave Mathematics Changes Experiments from Saying There is, to Denying There is Quantum Weirdness: it Changes How the Quantum World Appears to Work

Jeffrey H. Boyd

Retired

57 Woods Road, Bethany, CT, 06524-3103 USA

Jeffreyhboyd@gmail.com

Abstract

With a clever new interpretation of the Schrödinger equation, those quantum experiments that allegedly prove that the quantum world is weird, no longer do so. When we approach the math from an unexpected angle, experiments that appeared to prove that time can go backwards in the quantum world, no longer say that. Experiments that appeared to demonstrate that a particle can be in two places at the same time, no longer say that. This requires a counter-intuitive approach to the math, rather than a counter-intuitive approach to the quantum world. QM makes sensible assumptions and misperceives the quantum to be weird. Our math from the Theory of Elementary Waves (TEW) makes weird assumptions and discovers that the quantum world is actually sensible. We pay the weirdness tax up front. QM does not pay the weirdness tax and is penalized with a permanent misperception of the quantum world. This article is paired with a lively YouTube video (18 minutes is Ted Talk length) that explains the same thing: “New Schrödinger wave mathematics changes experiments from saying there is, to denying there is quantum weirdness.”

Introduction

Although many experiments appear to portray the quantum world as weird, that changes when we adopt a new approach to the mathematics of a Schrödinger wave packet. Experiments that previously appeared to say that entangled particles separated by vast distances can communicate with each other faster than the speed of light, no longer say that. Experiments that previously portrayed wave particle duality, now say that waves and particles are different. To our astonishment, the quantum world is transformed, simply by taking an innovative approach to quantum mathematics.

Some of the greatest geniuses of all time, including Einstein and dozens of Nobel laureates, tried to figure this out, and failed. Surprisingly, this article will give you the code needed to understand what went wrong, and straighten it out. We will first present the new approach to the Schrödinger wave packet, then apply that math to five quantum experiments to demonstrate that it works, and at the end of this article we will reveal how this solution was arrived at.[8-27, 37-39]

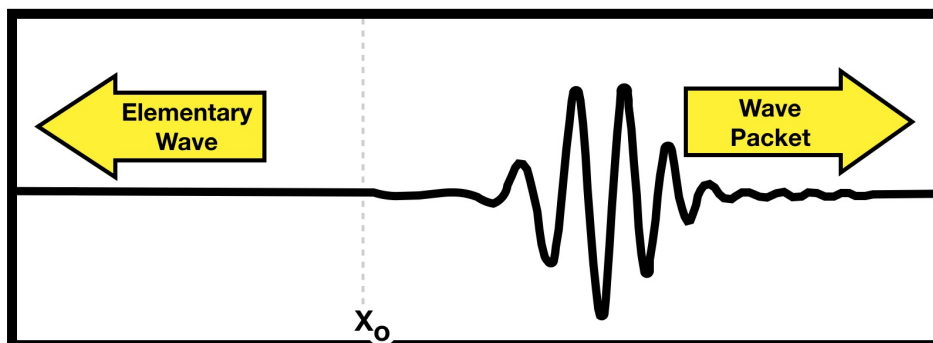

Figure 1: A one dimensional Elementary Wave (\mathcal{E}) moves to the \leftarrow left, while a Schrödinger wave packet (Ψ) moves to the right \rightarrow . They are two aspects of the same thing.

Fig. 1 shows a line with a sinusoidal wave packet on the right side, moving to the right. But what about the line itself? In what direction is it moving? Usually it is assumed to be stationary, representing the X axis. In our model the line is moving to the left, like a river flowing rapidly to the left, while a wave packet moves across the surface of the river, toward the right. The substrate or bottom layer is flowing to the left throughout Fig. 1. We call the river an Elementary Wave, for which we use the symbol \mathcal{E} from the ancient English and Viking alphabets. A Schrödinger wave packet (Ψ) is an aspect of an Elementary Wave, and is moving in the opposite direction.

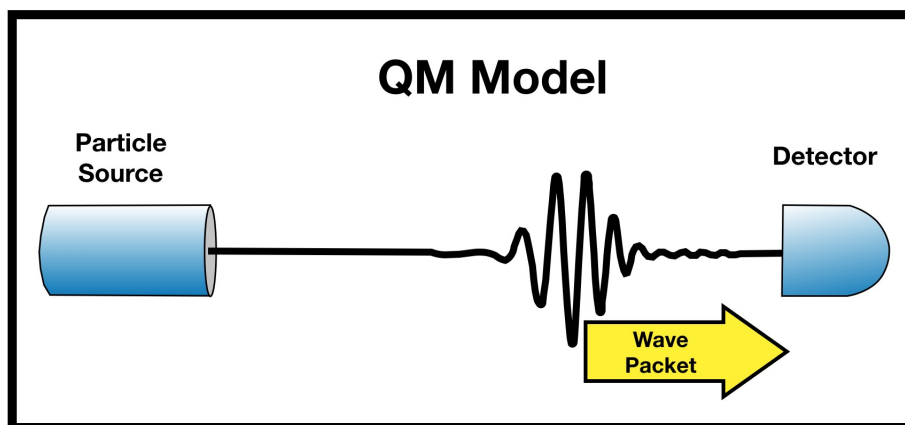

Figure 2: This shows the QM model with a wave packet carrying a wave-particle to the detector. The elementary wave is ignored by QM, as if it didn't exist. But it does exist, moving to the left, hidden inside the black line.

It is well known in QM that one wave can simultaneously flow in two opposite directions. For example, if a one dimensional plane wave coming from the right hits an infinite potential barrier it will bounce off and double back on top of itself. It becomes one wave moving simultaneously in opposite \leftrightarrow directions. What is different with TEW is that the second wave is usually absent, until something triggers it to emerge. Thus an elementary wave might travel to the left as a plane wave, but under specialized circumstances, when it encounters a particle, a Schrödinger wave packet will spring into existence, moving to the right and carrying the particle with it. **The defining feature of an elementary wave is that it carries an intrinsic trigger mechanism for a Schrödinger wave packet to**

emerge, moving in the opposite direction.

No Schrödinger wave packet can strike a detector unless the detector has invited it to do so.

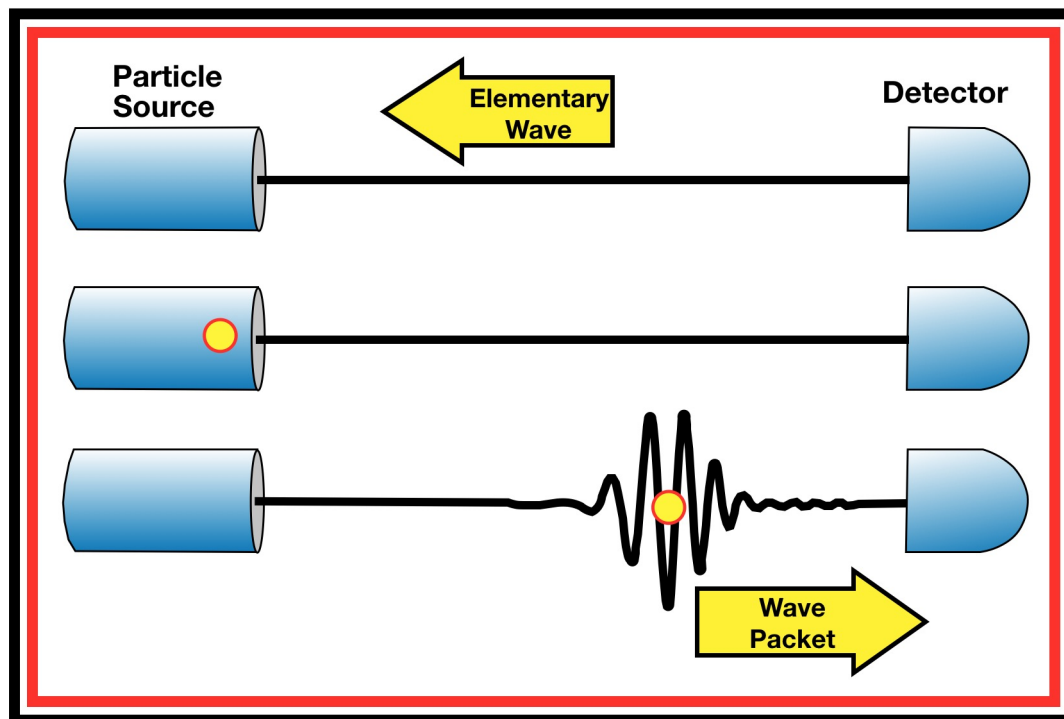

Figure 3: This is the most important diagram in this article. It shows what precedes the emergence of a Schrödinger wave packet. An animated video can be found in YouTube (18 min = Ted Talk length) cited in the Abstract above. The top row shows an elementary wave from the detector to the particle source. That is the detector’s “invitation.” Middle shows a particle about to be launched. Such a particle triggers a Schrödinger wave packet to emerge from inside the elementary wave. The bottom row shows the wave packet carrying the particle toward the detector.

0.1 How to ship an item back to company X

Consider a metaphor. You have an item that you want to send back to company X. There are two ways to do it. The QM approach is to open the door, watch the item fly out the door on its own, then be astonished when it arrives at the correct destination. To explain how that happened, you invent a far-fetched rationale for how and why your item managed to find its way to company X with such accuracy.

The TEW approach is that company X has advised you not to send the item until after they have mailed you the proper packaging. When you receive their envelope (top row of Fig. 3), you find that it consists of a container with just the right shape and padding and a bar code with precise instructions for which loading dock and which department in company X is to receive the item. You are not surprised when the item goes to exactly where it is supposed to go (bottom row of Fig. 3), because it is pre-arranged.

This is like how a particle travels to a specific detector. QM teaches that the particle is a wave particle that can just fly out the door on its own. They have no convincing explanation for how the item happens to arrive at the detector with a probability that is higher than predicted by random numbers.

TEW says the whole process started earlier. The first step is for the detector to be in contact with you. When you receive their mailing (top row of Fig. 3), it contains a wave packet. When you place the particle in that wave packet (bottom row of Fig. 3), it is shipped to precisely the detector to which it is supposed to go. It is all pre-arranged.

0.2 Zero energy waves

Many people believe, erroneously, that waves must carry energy. This is naive. A Schrödinger wave is a zero energy wave. It carries probability amplitudes, not energy. The Born rule is that if you take the absolute square of the amplitude you find the probability of a particle with that energy being there. Thus Schrödinger waves don't push particles around, or even influence them. Schrödinger waves describe Nature by providing us with the square root of the probabilities.

To reiterate: a Schrödinger wave packet may carry the amplitude for a Hamiltonian. But it does NOT contain, nor does it convey ENERGY.

In QM Hilbert space is often said to be highly abstract, in the stratosphere, in the "space of states." In TEW Hilbert space is interwoven in the Euclidean space of everyday experience. This idea of Hilbert space is explained in a reference in the Bibliography.[8]

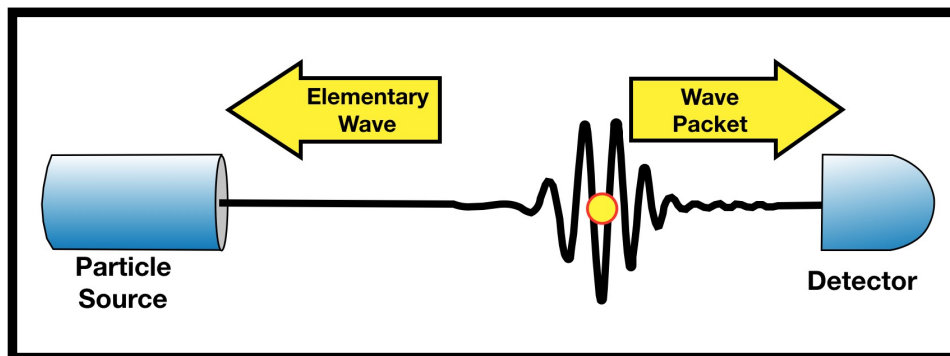

Figure 4: This is a simplification of the previous Figure. This diagram serves as a symbol or condensed version of the previous Figure.

Elementary waves are a natural extension of Schrödinger waves. They are zero energy plane waves

$$\Psi(x) = \mathbf{A}e^{-i(kx-\omega t)} \quad (1)$$

that are subject to wave dynamics. Each wave has an amplitude \mathbf{A} , sometimes interacts with physical objects, and can undergo wave interference. We use the letter \mathcal{E} to refer to such an Elementary Wave. It has unusual characteristics.

For example, as we said, it carries an intrinsic trigger mechanism for the emergence of a Schrödinger wave packet. In most \mathcal{E} this wave packet is a latent potential, not expressed.

As we said before, **the defining feature of an elementary wave is that it carries an intrinsic trigger mechanism for a Schrödinger wave packet to emerge, moving in the opposite direction.** Such a trigger is activated when the \mathcal{E} encounters a particle with precisely the right characteristics.

Such a trigger might be activated if the \mathcal{E} of frequency f approaches a particle whose De Broglie frequency is $f = E/2\pi\hbar$, and if the particle is about to be launched from a gun, and if the particle makes a random choice of that specific \mathcal{E} rather than the other incident \mathcal{E} 's. Under those circumstances the wave packet mechanism might be triggered and the wave packet would carry the particle off toward the detector from which that specific \mathcal{E} is propagating.

In TEW there is no wave particle duality. This is one of the axioms that define TEW. Another defining axiom is that wave function collapse occurs **before** we measure something. All the energy and momentum are carried in the particles, none of it in the waves.[8]

According to TEW, at every point in space there are an infinite number of \mathcal{E} traveling in all directions and at all frequencies, at the speed of light. Because they carry no energy, most of them are invisible to our detectors. Our detectors can only see a wave particle \mathcal{E} -II (where the symbol "II" signifies a particle). There is no such thing as a particle without an elementary wave. The intrinsic nature of particles is that they must always be attached to one \mathcal{E} or another. They can jump from one elementary wave to another. But naked particles, disconnected from all elementary waves do not exist.

TEW endorses all of quantum mathematics. QM was invented for the purpose of allowing us to understand and control atoms, molecules, and subatomic particles. Fig. 5 shows a solution to the Schrödinger equation, allowing us to make pictures of electron orbitals of the hydrogen atom. This is one of a vast collection of triumphs of QM. When compared to the purposes for which it was created, QM is the most successful science of all time. This is a domain where TEW has nothing to say other than applause.

The reason that TEW exists is because there is something wrong with QM, as evident in quantum weirdness. Our hypothesis is that TEW will dispel all weirdness.

1 Equations of an elementary wave (\mathcal{E})

Elementary waves can travel in two opposite directions simultaneously. Let's derive the equations.[32]

We will divide our elementary wave in Fig. 1 into the part traveling left, which we will call Ψ_L , and the part traveling right, which we will call Ψ_R . The point x_0 (Fig. 1) is where we divide left from right. We will use a subscript of "L" or "R" to label other variables also.

Our thinking is guided by an asymmetry. While a wave function might flow in both directions (symmetrical), energy and momentum only flow to the right, not the left. Thus we anticipate a tiger (Schrödinger Wave) moving to the right, but an elongated tail moving left with high speed but no energy. In many ways we are more interested in the tail,

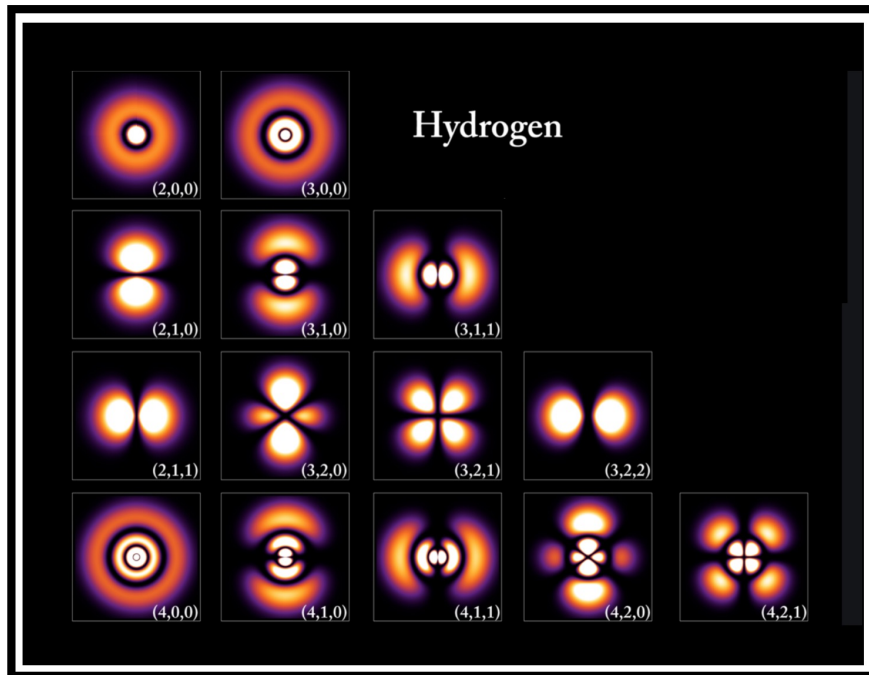

Figure 5: The Schrödinger equation allows us to picture orbitals in a Hydrogen Atom.

because if you control the tail, you control the tiger.

We define x_L to be a location to the left of x_0 (see Fig. 1) and x_R to be a position to the right. Our model is one dimensional. The vertical axis in Fig. 1 is amplitude. At x_0 the height and slope of the wave functions must be equal on both sides: $\Psi_L(x_L) = \Psi_R(x_R)$. We define both slopes to be zero at x_0 :

$$\frac{\partial \Psi_L}{\partial x_L} = \frac{\partial \Psi_R}{\partial x_R} = 0 \tag{2}$$

Furthermore the time, frequency and angular frequency must be equal on the two sides:

$$f_L = f_R \equiv f \tag{3}$$

$$\omega_L = \omega_R \equiv \omega = 2\pi f \tag{4}$$

The speed of the line is tricky. We claim the line moves to the left at light speed, while the wave packet (if it exists) moves to the right at v_R (often less than light speed). We will attribute light speed c to the Ψ_L and v_R to Ψ_R , remembering in the back of our mind that they are comprised of the same substrate, and the substrate is moving to the left at c .

Therefore the two wavelengths can be different. We will define

$$\lambda_L = \frac{c}{f} \text{ and } \lambda_R = \frac{v_R}{f} \tag{5}$$

Note that $\lambda_L \gg \lambda_R$ for wave packets moving slower than light.

$$\frac{v_R}{c} = \frac{\lambda_R}{\lambda_L} \tag{6}$$

The substrate Ψ_L carries zero energy. The wave packet Ψ_R also carries zero energy, as we said earlier, but it carries amplitudes for momentum. Variables such as E_R , p_R and k_R exist only on the right side of Fig. 1.

In other words $k_L \neq k_R$. We define

$$k_L = 2\pi/\lambda_L \quad \text{but} \quad k_R = p_R/\hbar \quad \text{where } p_R \text{ is momentum.} \quad (7)$$

Note that p_L and E_L are undefined. As we said before, velocity $v_L = c$, the speed of light. On the other hand, $v_R \neq c$ unless the wave packet moves at light speed.

We now define our two wave functions:

$$\Psi_L = \mathbf{A}e^{-i(k_L x_L - \omega t)} \quad \text{and} \quad \Psi_R = \mathbf{A}e^{i(k_R x_R - \omega t)} \quad (8)$$

where \mathbf{A} is an amplitude variable.

$$\text{Re}(\Psi_L) = \mathbf{A} \cos(k_L x_L - \omega t) \quad \text{and} \quad \text{Re}(\Psi_R) = \mathbf{A} \cos(k_R x_R - \omega t) \quad (9)$$

$$\text{Re}(\Psi_L) = \mathbf{A} \cos\left(\frac{2\pi x_L}{\lambda} - \omega t\right) \quad \text{and} \quad \text{Re}(\Psi_R) = \mathbf{A} \cos\left(\frac{p_R x_R}{\hbar} - \omega t\right) \quad (10)$$

Note that the ingredients with which to build a Schrödinger wave equation only exist to the right of x_0 .

1.1 The Schrödinger wave travels to the Right

We define

$$E_R = \text{kinetic energy} + \text{potential energy} \quad (11)$$

$$= 1/2mv_R^2 + u = \frac{p_R^2}{2m} + u \quad (12)$$

Taking the second derivative $\partial^2/\partial x_R^2$ of the wave function $\Psi_R = Ae^{i(k_R x_R - \omega t)}$ (Eq. 8 Right), we get:

$$\frac{\partial^2 \Psi_R}{\partial x_R^2} = \frac{\partial^2}{\partial x_R^2} e^{i(k_R x_R - \omega t)} = -k_R^2 \Psi_R = \frac{p_R^2}{\hbar^2} \Psi_R \quad (13)$$

$$\hbar^2 \frac{\partial^2 \Psi_R}{\partial x_R^2} = p_R^2 \Psi_R \quad (14)$$

$$(15)$$

Multiplying both sides of $E = p_R^2/2m + u$ by Ψ_R , we get:

$$E\Psi_R = \frac{p_R^2 \Psi_R}{2m} + u\Psi_R \quad (16)$$

which gives us the time independent Schrödinger equation.

$$E\Psi_R = -\frac{\hbar^2}{2m} \frac{\partial^2 \Psi_R}{\partial x_R^2} + u\Psi_R = \mathbf{TISE} \quad (17)$$

The time dependent (**TDSE**) equation can be easily derived by differentiating our wave equation $\Psi_R = e^{i(k_R x_R - \omega t)}$ by $\partial/\partial t$:

$$\frac{\partial \Psi_R}{\partial t} = -i\omega \Psi_R \quad (18)$$

We define $E_R = \hbar\omega$. Multiplying that by Ψ_R we get: (19)

$$E_R \Psi_R = \hbar\omega \Psi_R \quad (20)$$

$$-\frac{i}{\hbar} E_R \Psi_R = -i\omega \Psi_R = \frac{\partial \Psi_R}{\partial t} \quad (21)$$

$$E_R \Psi_R = -\frac{\hbar}{i} \frac{\partial \Psi_R}{\partial t} = i\hbar \frac{\partial \Psi_R}{\partial t} \quad (22)$$

We can substitute that into the TISE:

$$E_R \Psi_R = -i\hbar \frac{\partial \Psi_R}{\partial t} = -\frac{\hbar^2}{2m} \frac{\partial^2 \Psi_R}{\partial x_R^2} + u \Psi_R = \text{TDSE} \quad (23)$$

1.1.1 Wave Packet

Until now we have been focusing on waves of a single frequency f and momentum p_R . We now change that to a model that includes a cluster of frequencies Δf and momenta Δp_R . The reason we do so is because Fig. 1 shows a wave packet moving to the right. In order to construct a wave packet we need a cluster of frequencies that we add into a superposition that exhibits constructive interference in a narrow range of distance (Δx_R).

In order to have a cluster of frequencies on the right side of Fig. 1, we need to have the same frequencies on the left. As we said in Equation 1, $f_L = f_R \equiv f$. However, there is no wave packet on the left. Why? The left side of Fig. 1 is the area in which a superposition of wave equations adds up with destructive interference.

In the remainder of this article we will portray Elementary-Schrödinger Waves as having a nascent wave packet but not an explicit Schrödinger wave packet in most cases. The triggering of a Schrödinger Wave Packet to suddenly appear when the elementary wave approaches a particle, is an unusual event that occurs rarely and under special conditions.

In any volume of space there are a finite number of wave packets but an infinite number of elementary waves.

1.2 Elementary Wave traveling to the left

In Equation 8 we already stated the wave function for the elementary wave traveling to the left:

$$\Psi_L = \mathbf{A} e^{-i(k_L x_L - \omega t)}$$

When that wave equation is combined with the Schrödinger equation of the wave traveling right, you get a compound equation that defines and elementary wave \mathcal{A} .

Compound equations are well known in quantum mathematics. For example in a wave equation for a potential well it is commonplace to have a plane wave defined if $x < 0$ or $|A| < x$, but another wave equation for the well itself (when $0 \leq x \leq |A|$).

2 An experimental design to test whether QM or TEW is correct

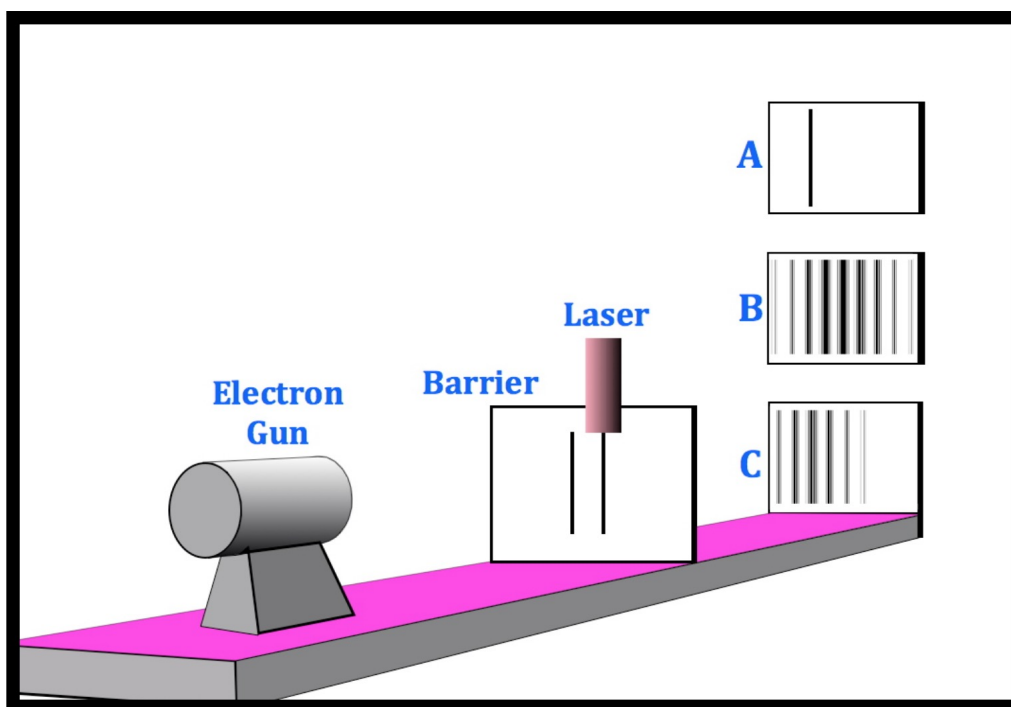

Figure 6: A proposed double slit experiment with different outcomes if QM is true, versus if TEW is true. If $t = 0$ is the instant when the electron gun is fired, and the Laser closes the right slit at $t \geq 0$. Therefore both slits were open at $t < 0$. On the right is a stack of three possible outcomes. QM predicts pattern A. TEW predicts pattern C. If both slits were always open, we would have seen pattern B.

Could QM and TEW be two versions of the same theory? Could TEW be an “interpretation” of TEW? No! The way to disprove that idea is if we can design an experiment that would produce different results if QM were true than if TEW were true. We have published three such experimental designs, one of which is found in Fig. 6.

Fig. 6 shows an experimental design that would have different outcome if the QM model of the double slit experiment is correct, or if TEW is correct. One electron at a time would be fired from the gun at time $t = 0$. Prior to that nanosecond when the gun is fired the Laser is off, so both slits are open for elementary waves moving toward the gun. At that nanosecond when an electron is fired from the gun, the Laser also fires and closes the right slit at $t \geq 0$.

According to TEW, if both slits are open prior to $t = 0$ then \mathcal{E} from the target screen will cause wave interference on the gun side of the double slit barrier. Therefore when a particle is fired at $t = 0$, it will be in the context of wave interference. Therefore the target screen will say, “wave interference.” If the particle wants to go through the right hand slit, which is now closed, then the right hand side of that interference fringe pattern will be obliterated, as evident in the Figure, in C. The appearance of the target screen will be different if QM is correct, than if TEW is correct.

If the target screen looks like A (see Fig. 6, right top), then QM is correct and TEW is wrong. If the target screen looks like C then TEW is correct and QM is wrong. Screen B is included to remind us what the target screen would

look like if there were no Laser.

By the way, if TEW is correct and we obtain pattern C, that would violate the rule of Complementarity that, “You cannot simultaneously see an interference fringe pattern and know which slit was used.”

3 Three illustrations showing how wave packets follow zero energy waves backwards

We previously showed in Fig. 2 that our wave packet is consistent with quantum math. We claim that TEW supports all of quantum math without change. In this section we will show how the TEW version of a Schrödinger wave packet fits perfectly with introductory QM with respect to a plane wave crossing a potential well or tunneling through a barrier. The emphasis in these three examples is that you should be familiar with what TEW is saying vis-à-vis these three experiments. TEW is designed to leave quantum math unchanged, but get rid of quantum weirdness. The weirdness banishing aspect will not be covered in this section.

Although the \leftarrow Elementary Wave ($\Psi_L = \mathbf{A}e^{-i(k_L x_L - \omega t)}$) is moving in the opposite direction as the Schrödinger wave packet, nevertheless, the wave packet works exactly the same as you learned in your introductory QM course, as evident in Fig. 2. The following figures are based on animations of wave packets from a computer at the Massachusetts Institute of Technology.[1] At the top of Fig. 7 you see a potential barrier in the black line (with energy of zero on the left and V_0 on the right). We define

$$E = \frac{\hbar^2 k_R^2}{2m_R} \text{ and} \quad (24)$$

$$V_0 - E = \frac{k_R \alpha^2}{2m_R} \quad (25)$$

In the center of Fig. 7 is time T1, showing a wave packet traveling toward the right, consisting of a total amplitude (in black) and the real part (in purple) of the amplitude. The energy eigenstate is a sum of plane waves $\Phi_E = Ae^{ikx}$ which is a wave packet that moves to the right and flattens out over time.

Below that in Fig. 7 are two yellow arrows, reminding us that although the elementary wave travels to the left, the wave packet travels to the right. Below that in Fig. 7 is a later time, T2, when an interesting turbulence is taking place inside the wave packet as it crashes into the barrier. This illustrates what we said earlier about waves moving in two opposite directions in QM. Three things are happening simultaneously:

$$\Phi_E = Ae^{ikx} \quad (26)$$

$$\Phi_E = A \frac{k - i\alpha}{k + i\alpha} e^{-ikx} \quad (27)$$

$$\Phi_E = A \frac{2k}{k + i\alpha} e^{-\alpha x} \quad (28)$$

Equation 26 is the wave moving to the right, Eq. 27 is the reflected wave moving to the left, and Eq. 28 represents the decaying potential in the “classically forbidden area” to the right of the barrier.

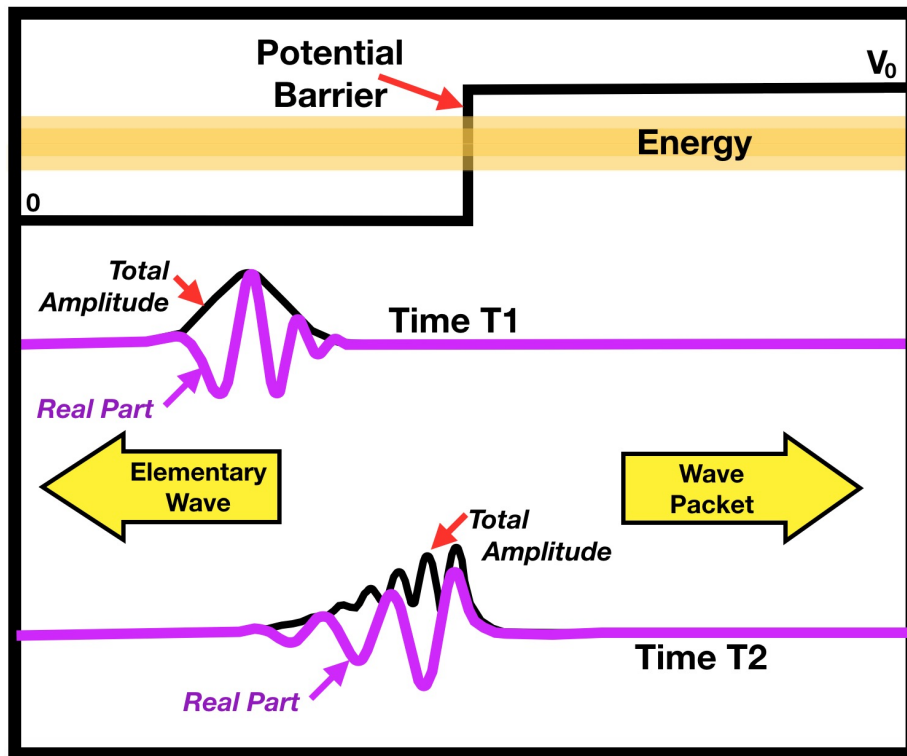

Figure 7: An elementary wave (i.e. Schrödinger wave substrate) moves ← left (see the yellow arrow), while a wave packet (see other yellow arrow) follows that substrate backwards → into the potential step barrier. This diagram shows snapshots at two different times: T1 and T2.

Because the wave is moving into the barrier at the same time as it is reflected in the opposite direction,

$$\Phi_E(x, t) = Ae^{ikx-\omega t} + A\frac{k-i\alpha}{k+i\alpha}e^{-ikx+\omega t} \tag{29}$$

$$\text{where } \omega = \frac{E}{\hbar} \tag{30}$$

therefore there are standing waves just to the left of the barrier.

You will notice that Fig. 7 and its discussion is identical to introductory QM. Why is that? The goal of TEW is to get rid of the weirdness of the quantum world, but preserve quantum equations unchanged. Our view is that Quantum Mathematics is the most magnificent and powerful science that humans have ever had, and must be preserved intact. Meanwhile there is something absurdly wrong with weirdness such as Schrödinger’s cat or backwards in time cause-and-effect.

Fig. 8 shows what happens when elementary waves encounter a wall, which is a thin barrier. In the classical world a particle would simply bounce off such a wall, not pass through it. In the world of elementary waves the waves “tunnel” through the barrier.

At time T1 in the center of Fig. 8 a wave packet moves to the right, toward the wall. Below that in Fig. 8 are two yellow arrows, reminding us that the elementary wave (i.e. elementary wave substrate) is moving to the left.

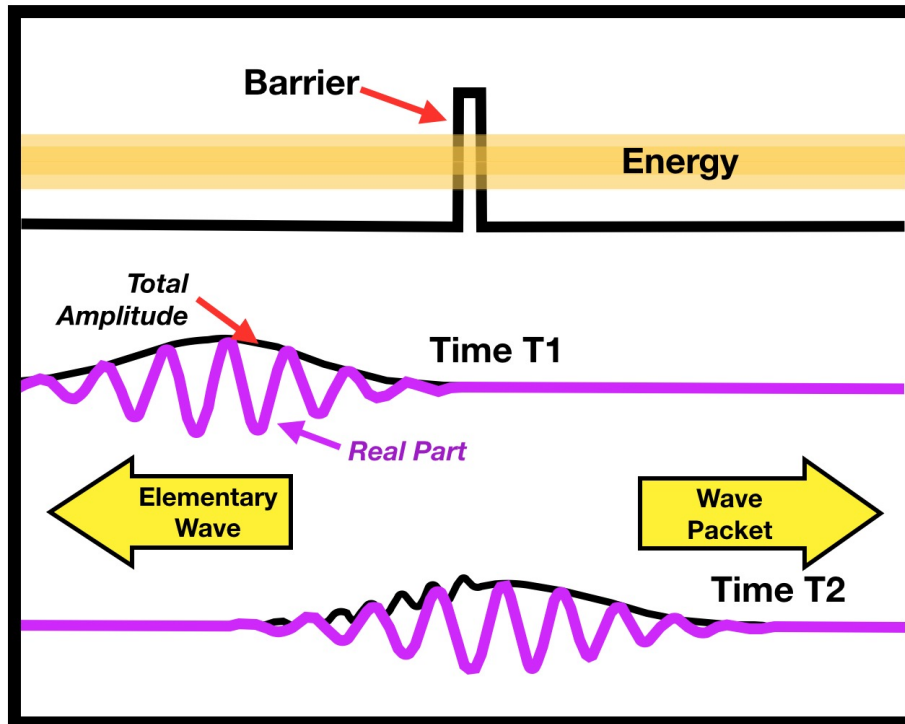

Figure 8: Tunneling: An elementary wave (substrate) moves to \leftarrow left, while a wave packet moves \rightarrow to the right, penetrating the barrier.

Meanwhile the Schrödinger wave packet is following its elementary wave in the opposite direction. At time T2 (bottom of Fig. 8) the wave packet has passed through the barrier, almost as if the barrier were not present. This is “tunneling”.

In QM the wave packet and the particle are the same thing. But in TEW we draw a distinction. TEW says there is no such thing as wave particle duality. So how does TEW understand “tunneling”? In our view the Schrödinger waves in our diagrams represent probability amplitudes. This means that if you take the absolute square of the Schrödinger equation $|\Phi_E|^2 = |\Phi_E^* \times \Phi_E|$ you would find the probability of finding a particle of that energy at that location.

Supposing you had an experiment with a potential barrier in the center, as shown in Fig. 8. If you ran the experiment a thousand times, you might find that the particle from a gun on the left would hit a detector on the left 390 times, and would hit a detector on the right 610 times. That is what we mean in TEW when we say that the wave and particle are different. If you ask, “If the particle is not identical with a wave packet, then how did it tunnel through the wall?” The answer is that we don’t know the answer. Like QM, TEW tells you amplitudes and probabilities, it does not tell you “How?” or “Why?”

Fig. 9 shows a potential Well. Once again the yellow arrow in the center remind us that the elementary wave is moving to the left. The wave packet moves to the right. They are two aspects of the same thing. Everything in this diagram carries zero energy. The Schrödinger wave packet carries an amplitude for energy. The particles carry all the energy and momentum, but particles are not shown in Fig. 9. The equations of Fig. 9 are shaped by normalizability and continuity of value and slope. Elementary waves moving to the left are not normalizable.

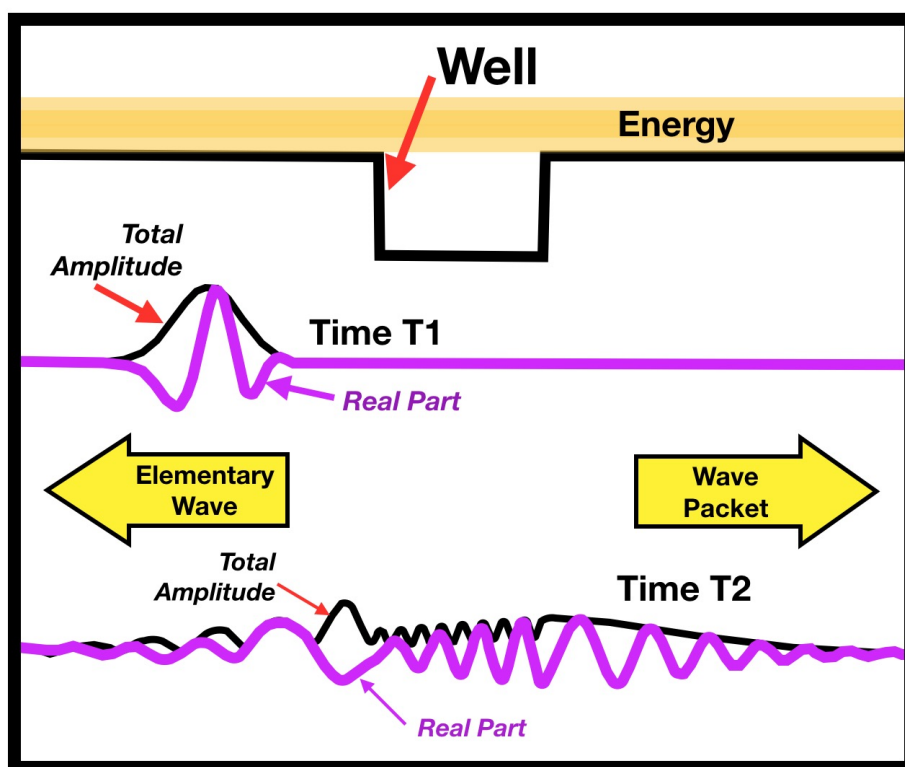

Figure 9: An elementary wave (substrate) moves to the ← left, while a wave packet moves → to the right spanning a Potential Well.

What we have accomplished so far is to define and describe these elementary waves that are the focus of this article. We turn now to the work for which TEW is famous, namely its ability to banish weirdness from quantum experiments. We will apply elementary waves to the analysis of experiments published in physics journals and accepted as valid by the scientific community. The experiments below are not thought to be controversial. Our re-interpretation of the results might be controversial if anyone knew about them, but mostly they are unknown.

4 A quantum eraser experiment that allegedly “proves” that the quantum world is weird

There is a famous experiment that QM experts say “proves” that the quantum world is weird. This experiment was published by Kim, et.al. in the year 2000. After we explain the QM viewpoint, we will re-analyze this experiment to show the TEW viewpoint.[36, 43] A quick summary is that QM claims that wave function collapse occurs at the detectors, whereas TEW claims wave function collapse occurs a dozen nanoseconds earlier, at the laser. That dozen nanoseconds means that the conclusions we draw from this experiment are totally different.

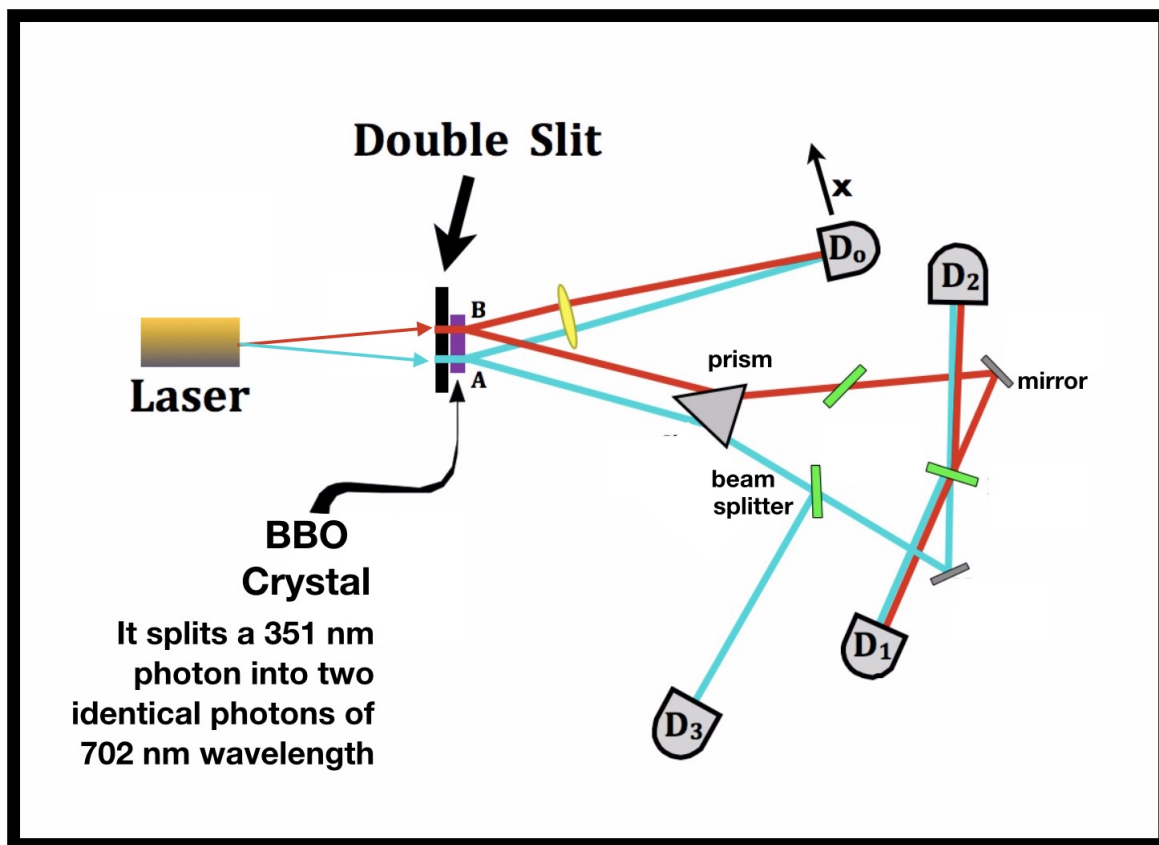

Figure 10: Apparatus used in quantum eraser experiment, color coded for whether a photon went through the upper slit (B = red) or lower slit (A = aqua blue) at the double slit barrier. After going through one slit or the other, each photon is split into two photons. The upper photon enters a traditional double slit experiment, but the lower photon enters a complicated apparatus to determine which slit was used.

4.1 The experiment as explained by QM

In a double slit experiment you see an interference fringe pattern on the target screen if and only if you are ignorant of which slit was used by the particle. This is called “complementarity.” If you discover which slit was used, then the pattern vanishes. John Wheeler wondered whether the same thing would be true if there were delayed choice. In other words, suppose you build an experiment in which an interference fringe pattern is etched on the target screen at a time when you do not know which slit was used. But then at a later time you discover that slit A was used. Wheeler’s hypothesis was that the interference fringe pattern on the target screen would be erased, backwards in time.

The experiment by Kim, et. al. appears to confirm Wheeler’s idea about backwards-in-time erasure of data (Fig. 10).

In the experiment each photon goes through a double slit barrier, then immediately encounters a BBO Crystal ($\beta - BaB_2O_4$) which splits it into two identical photons. One of these photons is sent up into a double slit experiment (Fig. 11) where an interference fringe pattern is made on the screen. That photon goes less distance, so the pattern on the screen is established BEFORE the lower photon randomly chooses to “click” another detector. If a red and blue

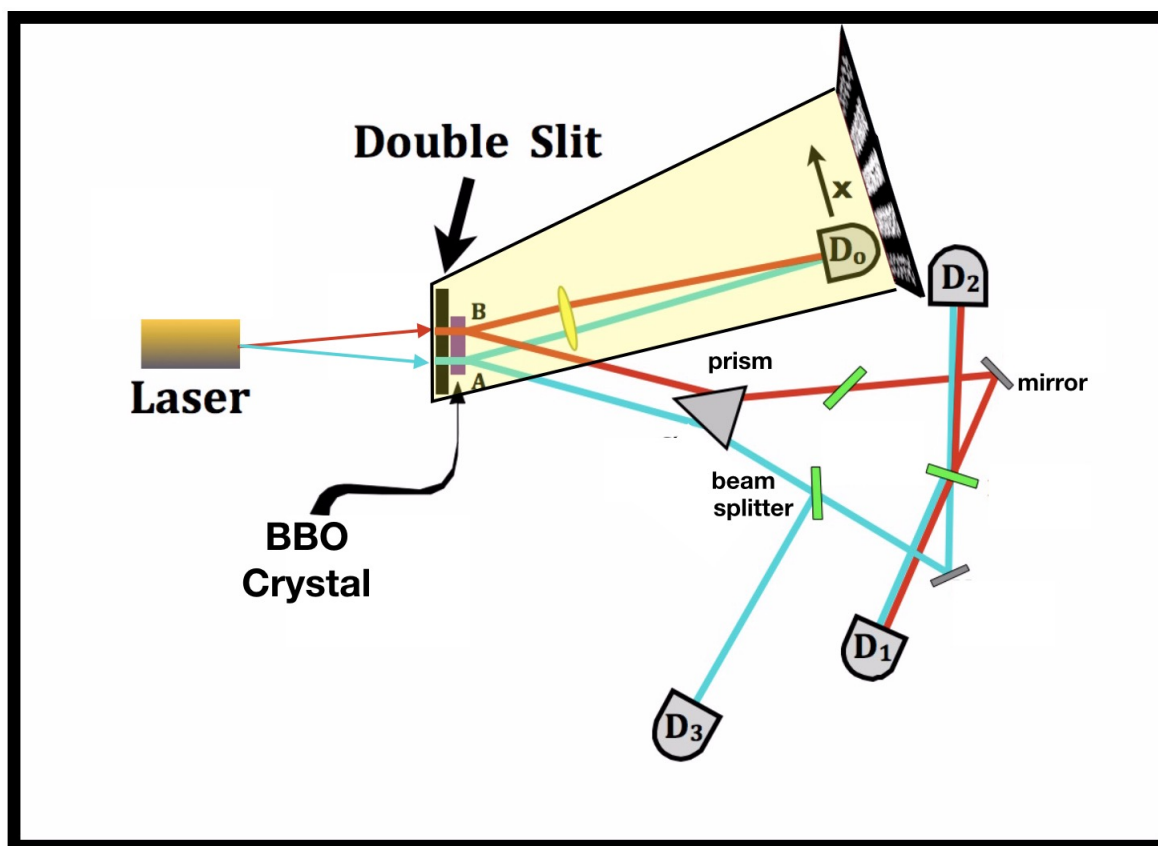

Figure 11: The upper photon in the yellow area is in a double slit experiment. The lower photon randomly enters detectors D_1 , D_2 or D_3 and informs us whether the photon came through slit A, or we don't know which slit was used.

line enter a detector (as in detectors D_1 and D_2) then we don't know which slit the original photon used. If only an aqua blue line enters a detector (as in detector D_3), then we DO KNOW that the photon came through slit A (the lower slit, color coded in blue).

When the computer assembles data, it connects data from two detectors: from D_0 paired with one of the other detectors. The final results show that if the lower photon subsequently "clicked" D_1 or D_2 then there is an interference fringe pattern visible on the target screen (in the upper area). But if the lower photon subsequently "clicked" detector D_3 then the interference fringe pattern on the target screen is erased and the screen is blank. The experimenters are confident that this means that data can be erased backwards in time if you discover at a later date which slit was used in a double slit experiment. "Backwards in time" means a nanosecond earlier.

If you limit yourself to the mathematics of QM then you are forced to say that this experiment proves that data can be erased backwards in time. That is an example of "quantum weirdness." You know you have encountered quantum weirdness when you get a migraine. Fortunately, if we view the experiment with the mathematics of TEW, then the same experiment reaches different conclusions.

4.2 TEW explanation of the quantum eraser experiment

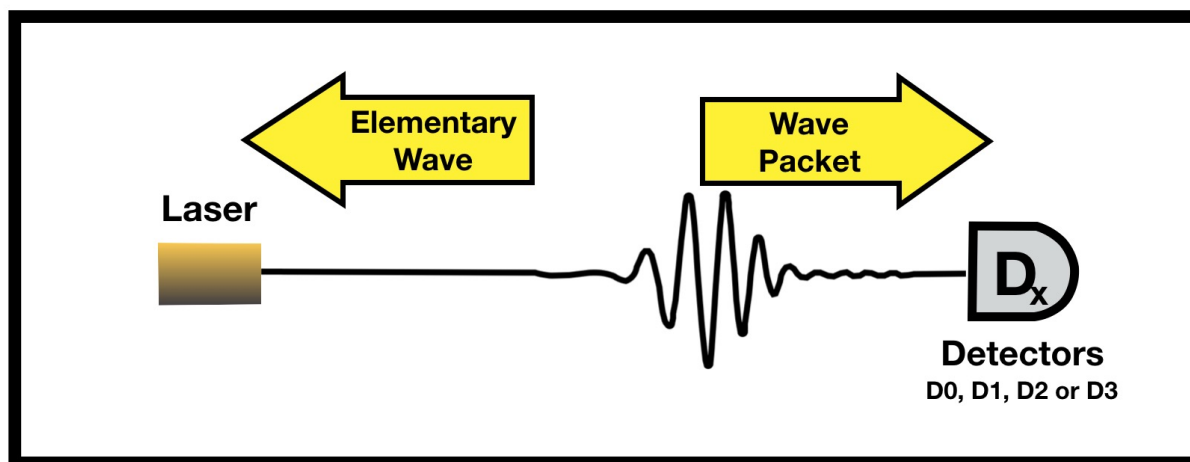

Figure 12: Elementary wave travels left and Wave Packet travels right, two aspects of the same thing.

According to TEW this is a simple experiment (Fig. 12). All decisions are made at the Laser, $20 \pm$ nanoseconds earlier than QM believes that decisions were made. Time does not go backwards. Data are not erased from the target screen. The target screen is a picture of wave interference in proximity to the laser.

TEW pictures an elementary wave traveling from each detector to the photon source (Laser). The elementary waves from different detectors compete with each other for the attention of the photon about to be launched. The photon randomly selects among three options (described below). After the photon leaves the laser this becomes a deterministic experiment. Each photon follows its Schrödinger wave packet back to the detector from which that elementary wave is coming.

What is reported on the target screen is **reality**. You cannot erase reality. The reality is that there is interference of two Elementary Waves at the laser iff there are two waves (red and blue) impinging on the laser. If there is only one Elementary Wave impinging on the laser, then of course there will be no wave interference to report on the target screen, because you cannot have wave interference with only one wave impinging on the laser.

So how could there be an interference pattern on the target screen at one time, and then it is erased? The answer is, that does not happen. What happens is that if data from the target screen is paired with data from detectors D_1 or D_2 , then there are both red and blue Elementary Waves impinging on the laser (Fig. 13), and therefore there is wave interference at the laser. But if data from detector D_0 is paired with data from detector D_3 , then only a blue wave (see Fig. 14) and therefore only one blue elementary wave is incident to the laser, and the final data show **no interference** because you cannot have interference with only one wave.

TEW proposes that the data describe reality. We ask the following question of these researchers. If you don't believe that your detector tells you the truth, then why bother doing research? We also ask a second question: If you claim that data from the target screen were erased, why didn't you design the experiment in such a way as to give us a picture of those data before they were erased? We claim the screen is blank (if Detector D_3 is involved) because there never was any data on that screen.

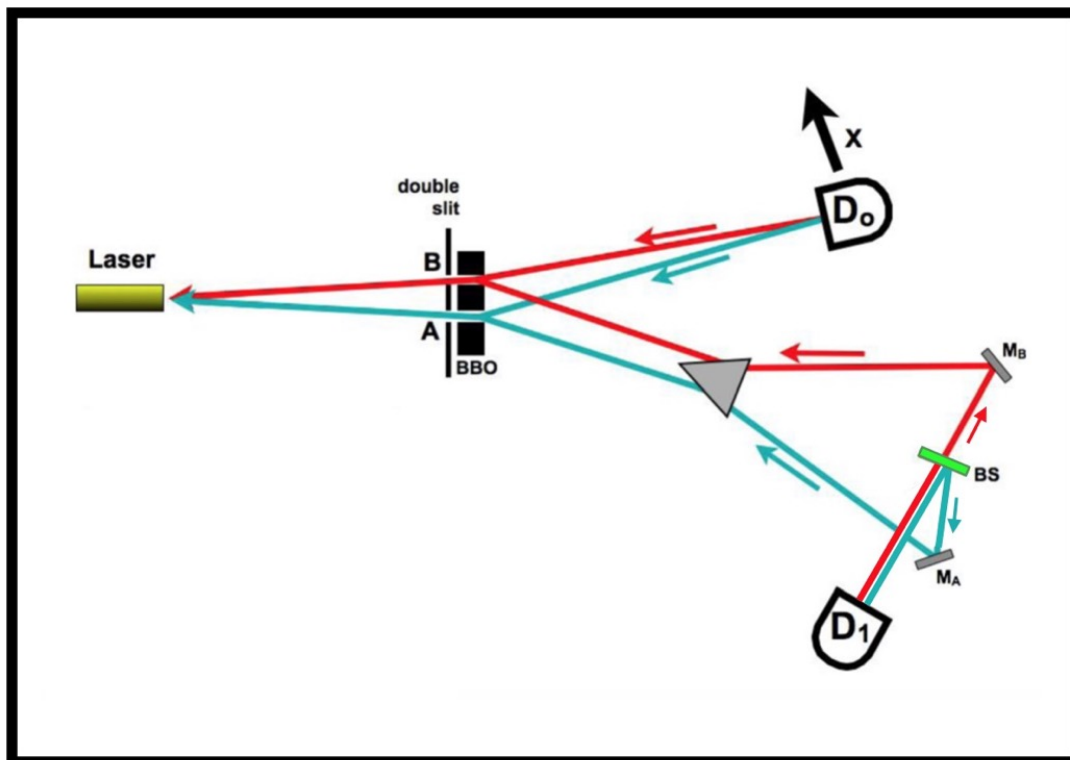

Figure 13: TEW model: Elementary rays of 702 nm (red or aqua) originate from the detectors and move to the BBO crystal, where they combine into red or aqua rays of 351 nm heading toward the laser. Since two rays (red and aqua) impinge on the laser, there *is wave interference*. Some detectors are omitted from this diagram, for simplicity.

The decision maker in this experiment is the photon as it is about to exit the laser. It is confronted with three incident elementary waves:

1. Waves from D_0 and D_1 coming through both slits and interfering;
2. Waves from D_0 and D_2 coming through both slits and interfering;
3. Waves from D_0 and D_3 coming only through slit A; no interference;

When the photon makes that choice the Schrödinger wave packet mechanism is triggered and that wave packet sweeps the photon off its feet and carries it away from the laser. When the wave packet reaches the BBO crystal it splits into two wave packets. Once the photon leaves the laser the ball game is over. The final data are determined. Nothing changes from that moment on. The photons simply follow their Schrödinger waves packet, which follow the elementary waves backwards to the detectors from which those waves are coming.

If the photon randomly chooses # 1 or # 2 (from the list above) then the final data will show an interference pattern on the target screen (D_0). If the photon randomly chooses # 3 (from the list above), then the final data will show no interference pattern on the target screen (D_0).

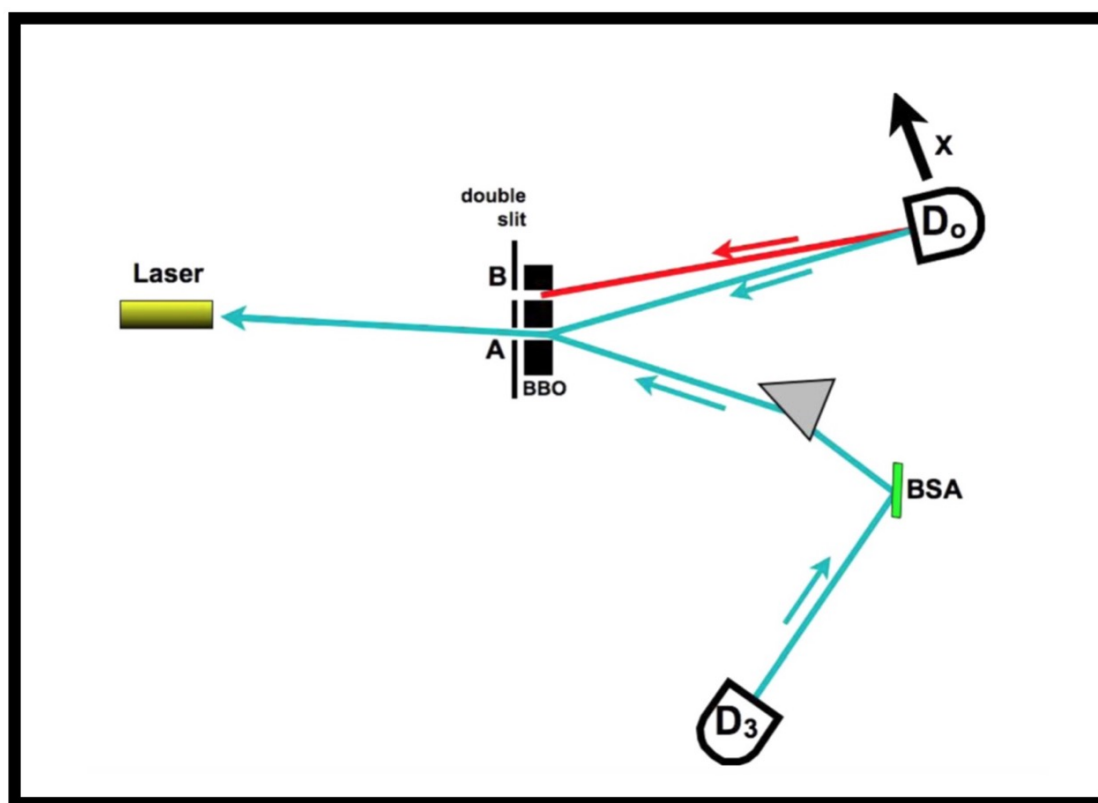

Figure 14: Simplified TEW model: Detector D_3 puts out an aqua elementary ray of 702 nm, but no red ray, for the simple reason that it cannot “see” slit B (the upper slit) because of how the equipment is constructed. Therefore there is no wave interference at the laser, because it takes two waves of 351 nm to make interference. The red line we might expect to impinge on the laser is missing.

4.3 When do you pay the “weirdness tax”?

In summary, we have just showed how the conclusions drawn from a quantum eraser experiment are different if we adopt the TEW mathematics. If this experiment says something unbelievable when you look at it through QM mathematical glasses, but says nothing remarkable when you look at it through TEW mathematical glasses, then the “weirdness” is located in the glasses, not in the quantum world.

When people reject TEW it is often because our starting assumption is “too bizarre”: namely our claim that a particle can only strike a detector if the particle was previously invited to do so by the detector. This “invitation” consists of a zero energy elementary wave that traveled first from the detector to the Laser, before any photon was fired. It means we live in a different world than we thought we lived in. It is a world where things are more interconnected than we realized!

QM says the same thing. They use the word “non-local” to describe this interconnectedness. We claim that “non-local” is too vague a term. “Elementary wave” is more specific. You know a tree by its fruit. The fruit of QM is that data can be erased backwards in time. The fruit of TEW is that data cannot be erased backwards in time.

Both QM and TEW say the quantum world is weird. But TEW pays the “weirdness tax” up front in the form of the doctrine that before a particle strikes a detector, the detector has to invite it. QM starts with more pedestrian and flat footed assumptions and ends up paying a tax penalty forever, in the form of a permanent wrong doctrine that the quantum world cannot be understood by humans. In the quantum world data can be erased backwards in time; in the human world this does not happen. That misperception is a scientific error, which is a heavy tax that QM must pay forever.

We advocate paying your “weirdness tax” right away. Life is easier that way. It allows you to see that the world of everyday experience (the classical world) is like a plate glass window. When you look at the quantum world through that window, it looks like what you would expect.

5 An attenuated laser experiment disproves wave particle duality

An obvious weirdness in the quantum world, the experts tell us, is that when a single particle is fired from a gun in a double slit experiment, it is a wave-particle that goes through both slits and interferes with itself. But experiments published by Pfleegor and Mandel show wave interference that cannot be attributed to the photons.[40,41]

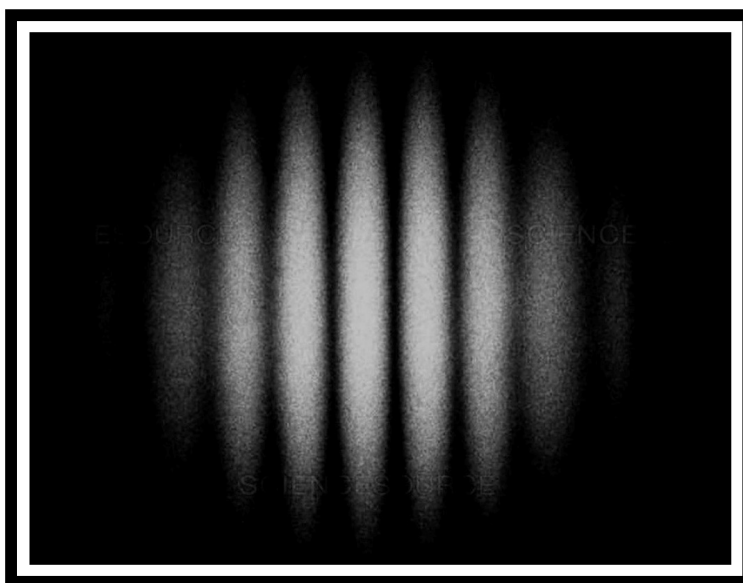

Figure 15: Two laser beams crossing and causing interference. Bright lasers, lots of photons.

It is well known that when laser beams cross there can be an interference fringe pattern (Fig. 15). In this case a photon only travels through one slit (i.e. from one of the two lasers) so it cannot interfere with itself. The question is whether this effect would persist if you turn down the intensity of the light to such an extent that there is no photon from either laser in the experiment most of the time. In other words, is the interference pattern caused by the waves even without photons? Obviously you would have to run this experiment for a long time in order to accumulate enough photons to see anything because it takes a photon to make a detector “click.”

In the Pfleeger and Mandel experiment they did exactly that. They used two “attenuated” laser beams, such that every photon is separated by 200 times as much time when there is no photon. So the photons cannot interfere with each other.

To reiterate, they designed an experiment in which each photon cannot interfere with itself (because it comes from only one laser or the other but not both), nor can it interfere with a photon before or after it. That means that wave interference exists but cannot be attributed to the photons. The experiment shows that zero energy waves from one laser interfere with zero energy waves from the other laser. That contradicts the wave particle duality doctrine.

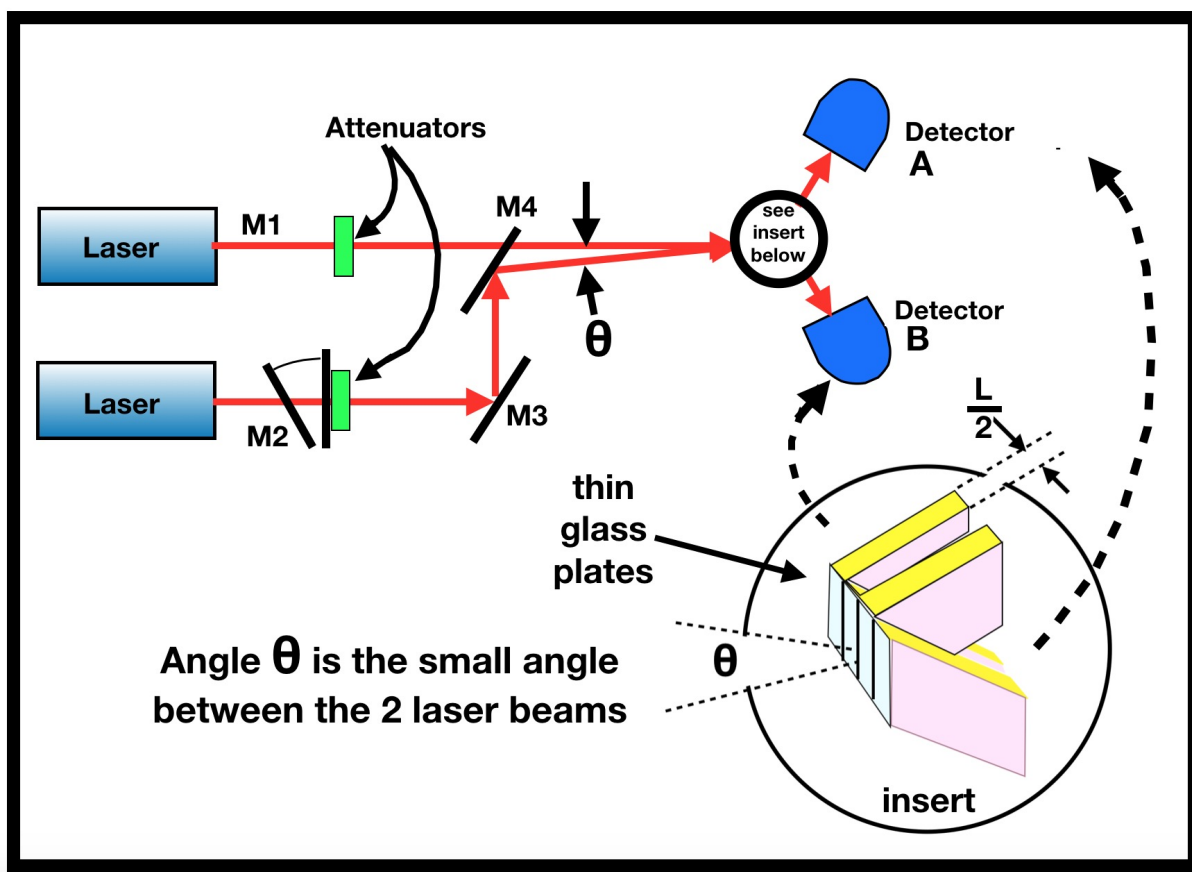

Figure 16: Equipment used by Pfleeger and Mandel. Two He-Ne lasers with correlated polarization put out attenuated beams: one photon from time to time. The two beams (shown as red arrows) have a small angle θ between them. At the point where the beams intersect, the contents of the circle are shown in an insert in the lower right: stacks of thin plates of glass. All the odd numbered plates (1, 3, 5 . . .) send photons to one detector and the even number send photons to the other detector. There is a relationship between the width of the interference fringe maxima (l), the width of a glass plate ($L/2$), and that is related to the angle θ .

Fig. 16 shows the equipment used by Pfleeger and Mandel to make attenuated laser beams. There were very few photons. Every time a photon was fired and detected, there was two hundred times that much time elapsed before the next photon was fired. Therefore the laser beams that crossed each other, and interfered with each other, were almost always lacking in photons. Of course you couldn't see the interference until a photon came along and made it visible to

the detectors.

Data from this experiment force us to say that there are zero energy waves in Nature and that particles, when they happen to come along, follow those waves. Just as a kayak coming down a river encounters standing waves, similarly the bobbing about of the particle in this experiment makes the interfering waves visible. The standing waves in the river are present whether a kayak comes down the river or not.

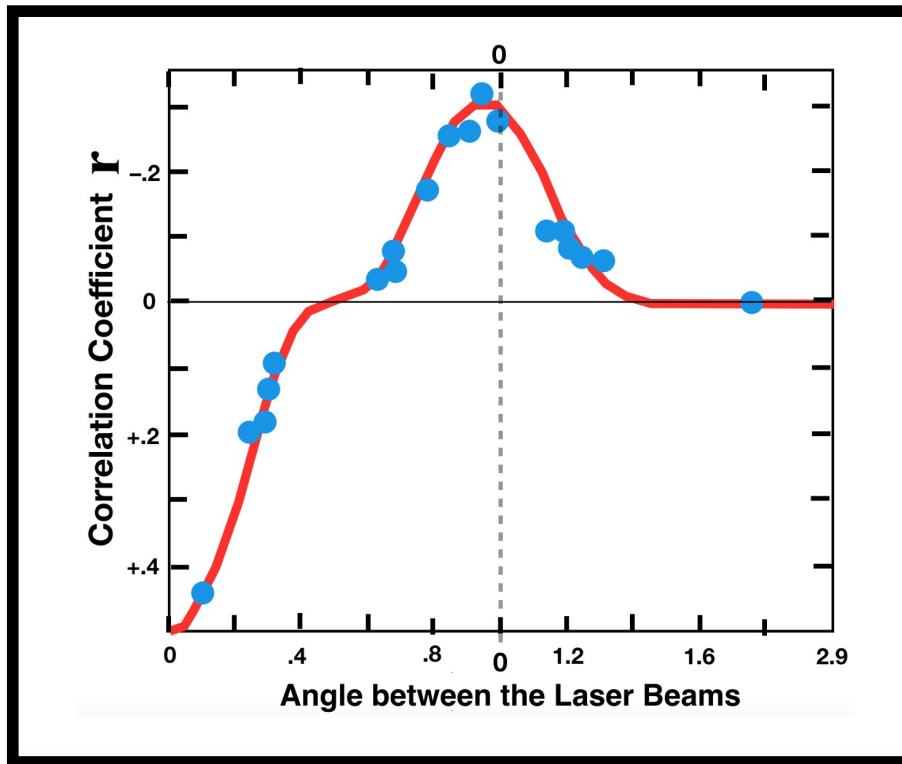

Figure 17: Correlation of two Lasers for 19 photons, compared to the red line predicted by QM equations. The interference fringe (proof of wave interference) is found in the peak at point “0” on the horizontal axis. Statistically the blue dots fall on the red line so accurately that Pfleeger and Mandel report that this graph proves the interference effect for which they were searching.

Fig. 17 shows the results of Pfleeger and Mandel’s experiment. Obviously their thesis stands or falls depending on whether the blue dots (each representing one photon) fall along the red line. Therefore we need to discuss briefly the equations that the red line represents. The correlation coefficient r is defined:

$$r \equiv \frac{\langle \Delta n_1 \Delta n_2 \rangle}{\left[\langle (n_1)^2 \rangle \langle (n_2)^2 \rangle \right]^{\frac{1}{2}}} \tag{31}$$

The experimenters say that variables n_1 and n_2 should be anti-correlated. Any photon must be seen by one detector or the other. If it is seen by one, then it will not be seen by the other. That is the reason for the anti-correlation.

Equation 31 is derived from a long line of equations:

$$\langle n_1 \rangle = 1/2\alpha_1 cLbN(I_1 + I_2)T \quad (32)$$

and

$$\langle (n_1)^2 \rangle = \langle n_1 \rangle + \frac{1}{2} \frac{\langle n_1 \rangle^2}{N^2} \left[\frac{2}{\sqrt{\frac{I_1}{I_2}} + \sqrt{\frac{I_2}{I_1}}} \right]^2 \times \left[\frac{\sin(\pi NL/l)}{\sin(\pi L/l)} \right]^2 \left[\frac{\sin(\frac{1}{2}\pi NL/l)}{\frac{1}{2}\pi L/l} \right]^2 \quad (33)$$

and

$$\langle n_1 n_2 \rangle = \langle n_1 \rangle + \frac{1}{2} \frac{\langle n_1 n_2 \rangle}{N^2} \left[\frac{2}{\sqrt{\frac{I_1}{I_2}} + \sqrt{\frac{I_2}{I_1}}} \right]^2 \times \left[\frac{\sin(\pi NL/l)}{\sin(\pi L/l)} \right]^2 \left[\frac{\sin(\frac{1}{2}\pi NL/l)}{\frac{1}{2}\pi L/l} \right]^2 \cos \frac{\pi L}{l} \quad (34)$$

We refer the reader to the original manuscripts by Pfleegor and Mandel for a definition of these variables. The point is that attenuated laser interference experiments have their own tradition of intricate equations. When you explore specialized areas of scientific research you must decide whether or not you trust the researchers and the journal referees. Do you trust that scholars conducting attenuated laser experiments know what they are doing and have integrity? We do. Therefore there is no need to show the reader more of the Pfleegor and Mandel equations.[40, 41]

5.1 TEW view of the Pfleegor and Mandel attenuated laser experiment

Fig. 18 shows our interpretation of the data from this experiment. To simplify the diagram we show the upper laser connected to a purple line, and the lower laser connected to a black line. In all three diagrams elementary waves travel from the detector to each of the lasers. In the top diagram a photon has triggered the emergence of a Schrödinger wave packet on the purple line. In the bottom diagram a photon has triggered a black wave packet. The middle diagram shows the most common condition, namely that there were no photons most of the time, just elementary waves interfering with one another.

Our interpretation of the experiment is almost identical to that of Pfleegor and Mandel, except for the direction of the zero energy waves. The data in Fig. 17 show wave interference. That interference cannot be attributed to a photon interfering with itself because the photon only came through one slit. Nor can the interference be attributed to two separate photons interfering because the lasers were so attenuated that there was a long elapse of time after one photon was fired, before another one was fired.

The only other possibility is that zero energy waves from one laser were interfering with zero energy waves from the other laser. This contradicts the doctrine of wave particle duality, because the experiment shows that waves can exist without particles.

We have proved therefore that there are some zero energy waves in Nature even when no particles are around, and that these waves can interfere with one another.

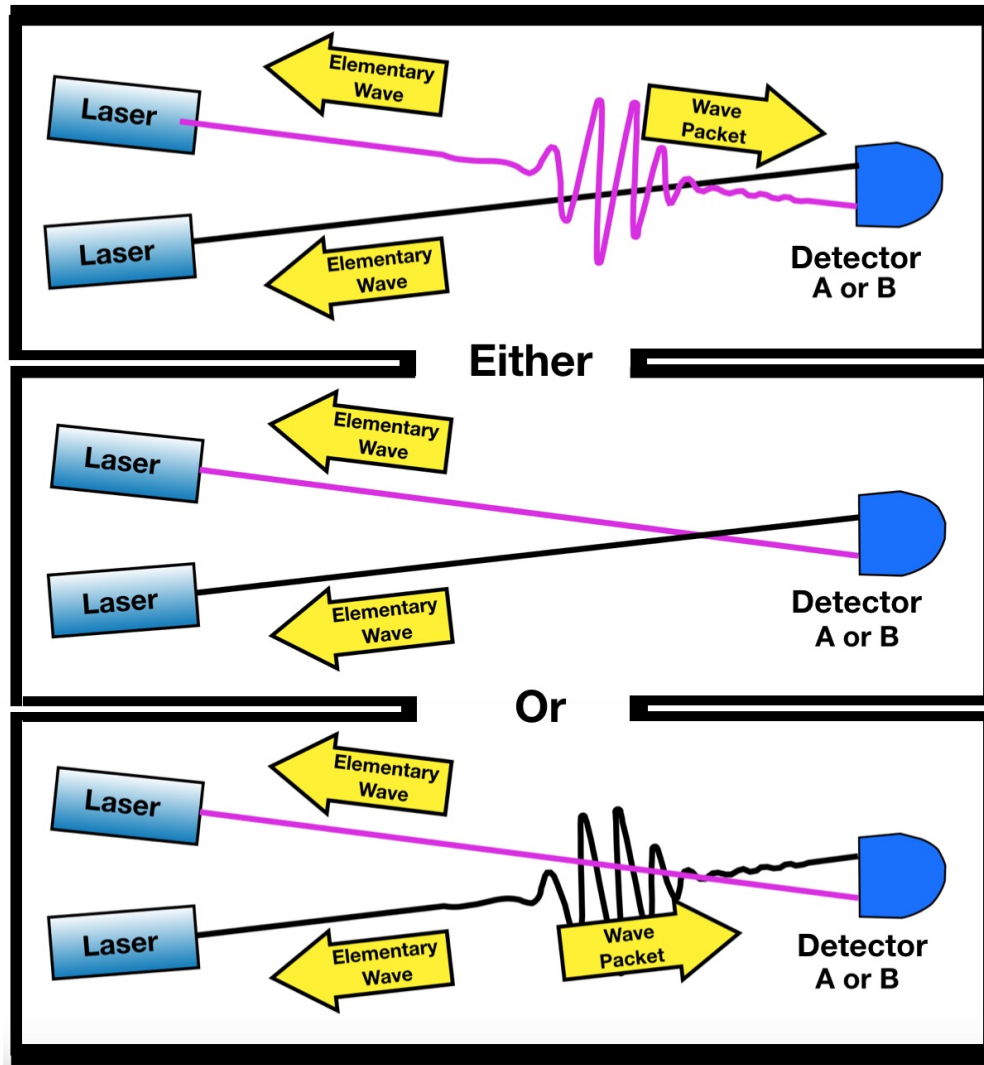

Figure 18: The 3 diagrams represent 3 things happening. Top shows an elementary wave traveling from detector to laser which triggers a Wave Packet to move toward the detector. Middle diagram is the usual situation: two elementary waves interfering without any Wave Packets. Bottom shows that a Wave Packet has come along, on the black trajectory.

6 The double slit experiment allegedly “proves” that a particle can be in two places simultaneously

QM experts say the double slit experiment proves wave particle duality (Fig. 19). Einstein decisively proved that the QM model must be wrong.

Einstein proved that Fig. 19 cannot possibly be the explanation of how this experiment works. He said that whenever a dot appears anywhere, the wave particle has been localized to be one discrete dot. At that instant it is necessary that every part of the Schrödinger wave everywhere else vanish faster than the speed of light. If that did not happen then the residual parts of the Schrödinger wave could produce a second dot, which would be impossible. No one has

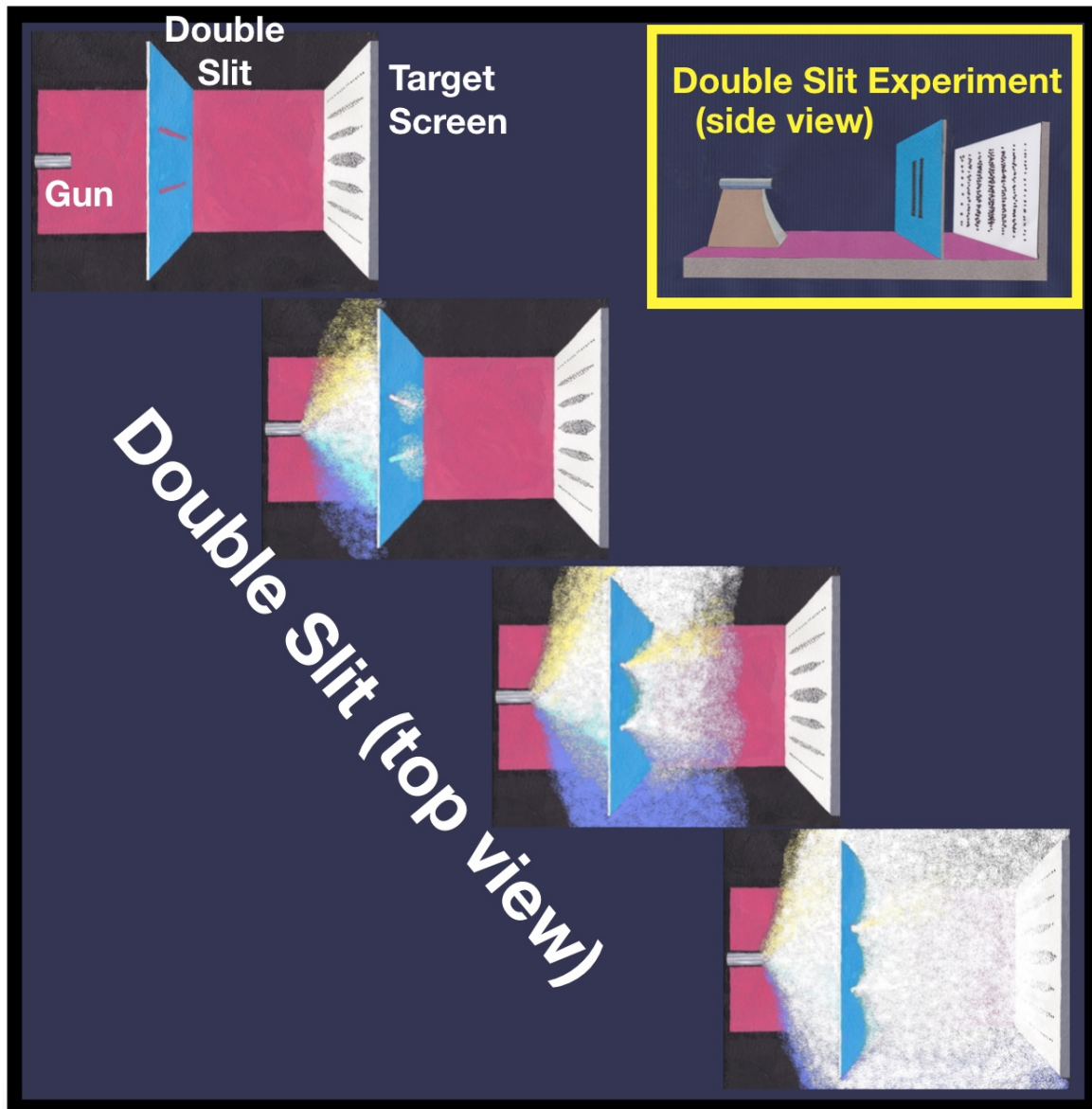

Figure 19: A QM model of a double slit experiment: a cloud of probability amplitudes → propagates to the right like a fog. When a dot appears anywhere, there is wave function collapse.

ever explained how the entire Schrödinger wave could vanish instantaneously, faster than the speed of light.

What Einstein’s proof means is that we have to find a different explanation for how the double slit experiment works.

TEW provides a solution that is not subject to the Einstein complaint. Elementary waves emanate from every point on the target screen, and move ← toward the double slit barrier, as shown in the bottom half of Fig. 20. There are hundreds of zero energy elementary waves, the vast majority of which we can ignore. We only need to pay attention to those waves with a frequency f that corresponds to the De Broglie frequency $f = E/2\pi\hbar$ of the particle that is about to be emitted.

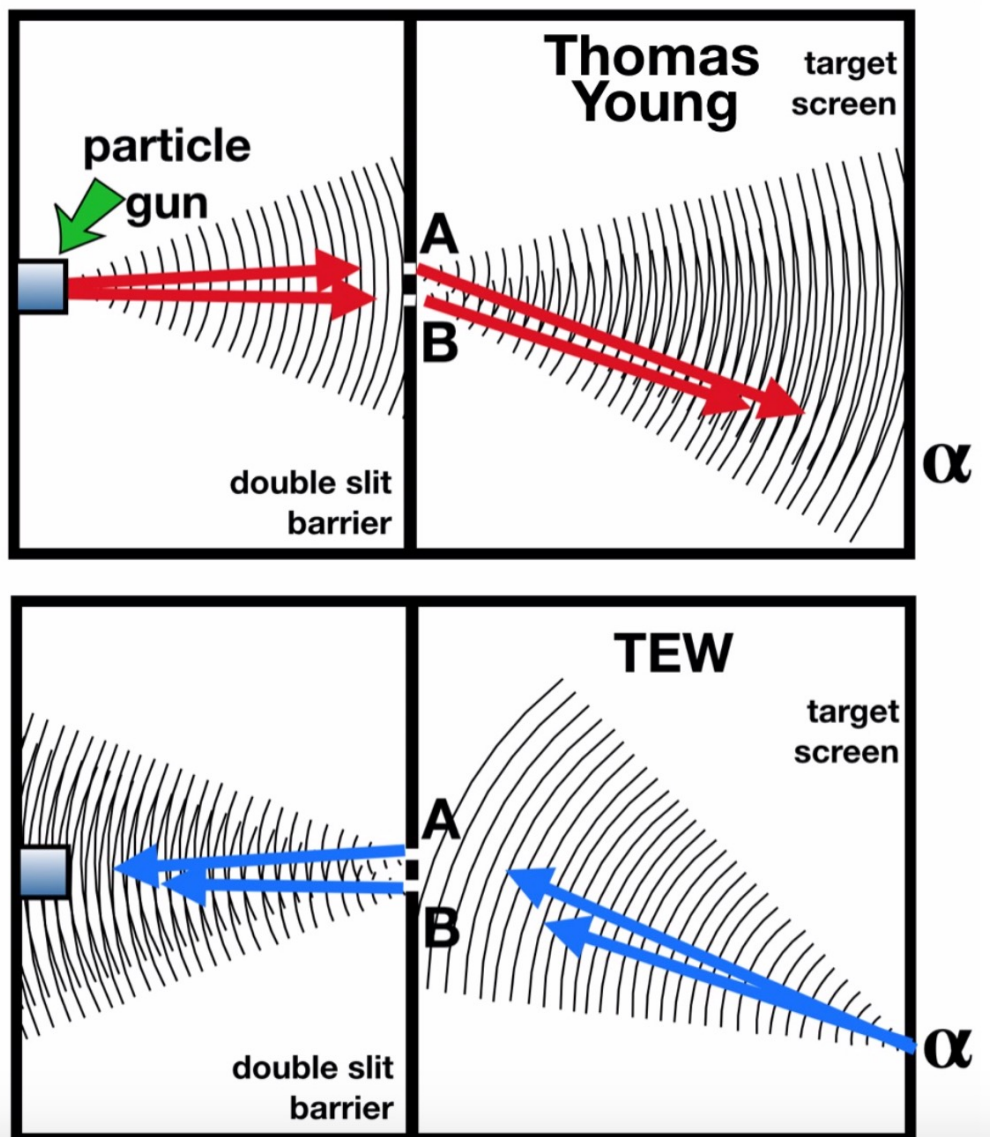

Figure 20: The top diagram shows Thomas Young’s explanation of the experiment. The bottom diagram shows elementary waves coming from point α on the screen, refracting through the two slits and impinging on the particle gun. Young thought wave interference was located to the right of the double slit barrier; TEW says it is located to the left.

We use the word “hundreds” metaphorically to mean a “large finite number.”

According to TEW elementary waves from every point on the target screen travel to the left, through both slits, interfere as they impinge on the gun, and then the particle randomly triggers one specific wave to produce a Schrödinger wave packet. The wave packet follows the elementary wave trajectory (backwards) through one and only one of the slits (it doesn’t matter which) to exactly that point α from which that specific elementary wave is emanating. When the particle leaves the gun the experiment becomes deterministic: the particle is tethered to point α , where it is destined to make a dot. This mechanism will produce exactly the same wave pattern on the target screen, and the same mathematics, as the QM model (Fig. 21).

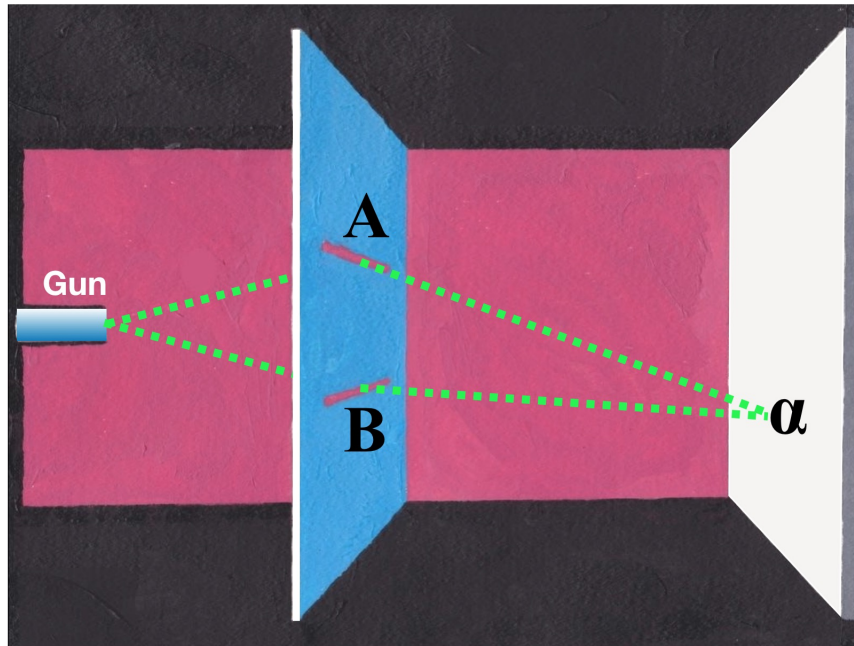

Figure 21: This diagram proves that the results of QM and TEW are the same, and explains why that is true. There are two pathways (dotted lines): from the gun to slit A to point α on the target screen; and from the gun to slit B to point α . If we measure them both, subtract one from the other, then divide by the wavelength (λ), the modulo divided by 2π is the phase difference. Our point is that the phase difference ($\theta_B - \theta_A$) is the same whether the waves move from left to right, or right to left. The phase difference produces the wave pattern in the final dataset.

Waves from various points on the target screen refract through the two slits with a phase difference ($\theta_B - \theta_A$). The phase difference determines whether the wave interference incident to the gun is constructive, intermediate, or destructive. That influences the probability of the particle randomly choosing that particular incident wave. For example, if the point α on the target screen is located such that there is a phase difference of $(\theta_B - \theta_A) = \pi$ then there will be destructive interference at the gun and therefore no likelihood that a particle will be triggered by that incident wave, and therefore point α will remain black in the final dataset.

Fig. 21 shows why the TEW mechanism precisely reproduces the QM pattern on the target screen, and the mathematics of the double slit experiment. The equation describing the elementary wave as it moves toward the particle gun is (Equation 8), which is:

$$\Psi_L = Ae^{i((2\pi x_L/\lambda) - \omega t)} \tag{35}$$

On the other hand, the equation describing the Schrödinger wave packet as it moves away from the particle gun (Equation 23), is:

$$-i\hbar \frac{\partial \Psi_R}{\partial t} = -\frac{\hbar^2}{2m} \frac{\partial^2 \Psi_R}{\partial x_R^2} + u\Psi_R = \text{TDSE} \tag{36}$$

Our model (bottom of Fig. 20) differs from the conventional model of the double slit experiment (Fig. 19) in that there are hundreds of such elementary waves, traveling in the opposite direction as expected, and a random decision is made among them by the particle. As we showed elsewhere, this picture involves a concept of Hilbert space and

Schrödinger waves that is no longer located in the abstract stratosphere. Rather, Hilbert space and Schrödinger waves are part of the “here and now” of everyday experience.

6.1 A question asked by John von Neumann

Von Neumann said that the Schrödinger equation is a deterministic equation. He said that it was therefore a mystery how the randomness got into QM. Our answer is that the randomness can be blamed on the particle. The randomness is not due to the Schrödinger equation. There are hundreds of elementary waves impinging on the particle in the gun. We know from Brownian motion that particles are intrinsically random. When the particle randomly chooses one elementary wave to respond to, that decision has an impact on the trigger mechanism of that wave. It causes a Schrödinger wave packet to abruptly emerge from that one elementary wave. No other incident wave blossoms a Schrödinger wave packet.

Therefore it is the particle that introduces randomness into QM. As we said, the particle’s random decision causes one elementary wave to change and be different than all its siblings. Not only is that Schrödinger wave packet deterministic (as von Neumann says), it follows backwards the path of the elementary wave from which it emerged, so that a dot appears on point α on the target screen with a probability of one. We assume that α is that point from which the elementary wave is emanating.

6.2 Complementarity explained

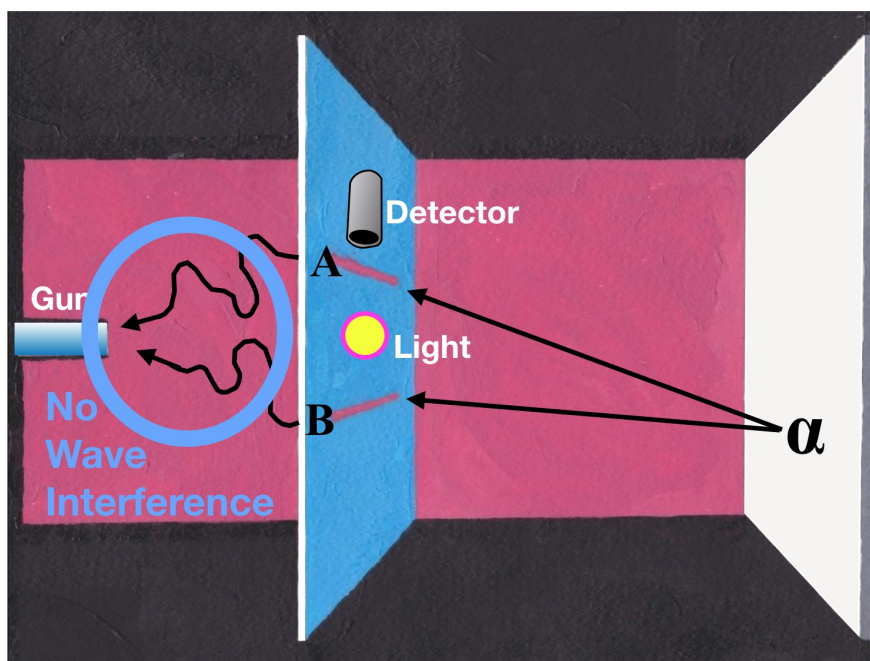

Figure 22: **Complementarity explained:** If the light is turned on, then there is no wave interference in proximity to the gun.

Our model provides a simple explanation of complementarity. If you know which slit a particle uses then the interference fringe pattern on the target screen vanishes. With TEW this is no longer a mystery.

In order to know which slit we need to introduce a lamp (or low energy source) into the experiment, along with a detector as shown in Fig. 22. Whenever the light is switched “ON” that energy is much more than the zero energy elementary waves. The light’s energy destroys the superposition additivity of the elementary waves. If two waves cannot be added together into a superposition, then two waves cannot interfere with one another. Therefore waves from point α on the target screen, when they travel through slit A will not interfere with waves from point α that travel through slit B. What the final data on the target screen gives us is a picture of wave interference incident to the gun. There would be no such interference if the light were turned on.

The final data on the target screen simply tell us the truth, which is “You have destroyed the wave interference at the gun.” There is nothing mysterious about it.

Empirically we observe that sometimes elementary waves possess, and other times they do not possess superposition additivity. Mostly they lack that capability. For example, if two adjacent points α and β on the target screen send elementary waves towards the two slits and the light is off, the waves from α cannot be added to the waves from β . We don’t know why this is true. We simply observe Nature and tell you what we see.

7 The Bell test experiments allegedly “prove” quantum weirdness

The Bell test experiments are alleged to be a fountain of quantum weirdness. That weirdness disappears when we apply TEW technology to the experiments.[7,27,33]

It is well known that when Alice and Bob test their entangled photons at random angles θ_1 and θ_2 , their results obey this equation: $P = \cos^2(\theta_2 - \theta_1)$ where P is the probability of both Alice and Bob seeing a photon simultaneously. That equation contradicts Einstein’s prediction. We will use the word “probability” instead of “coincidence rate,” which is the word used in QM discussions of this phenomenon.

7.1 Bi-Rays defined

TEW can explain the results based on Bi-Rays which consist of two elementary rays traveling coaxially in opposite directions (Fig. 23). A pair of photons, when emitted, is already embedded in such a Bi-Ray that extends from Alice’s equipment, across fiberoptic cable to Bob’s equipment. The relationship $P = \cos^2(\theta_2 - \theta_1)$ is intrinsic to that Bi-Ray. Therefore Alice’s equipment does not send a “signal” to Bob’s equipment. The experimental results are explained with a small number of starting assumptions, and with no evidence of quantum weirdness.

Here is a more detailed explanation of what we just said.

Einstein proposed in 1935 that something was missing from QM. His thought experiment was to imagine that an atom produces two particles with equal but opposite spin traveling in opposite directions. If you do an experiment on one, you learn something about the other. The term “local realism” has become a code word meaning “Einstein’s idea of how the Nature works.”

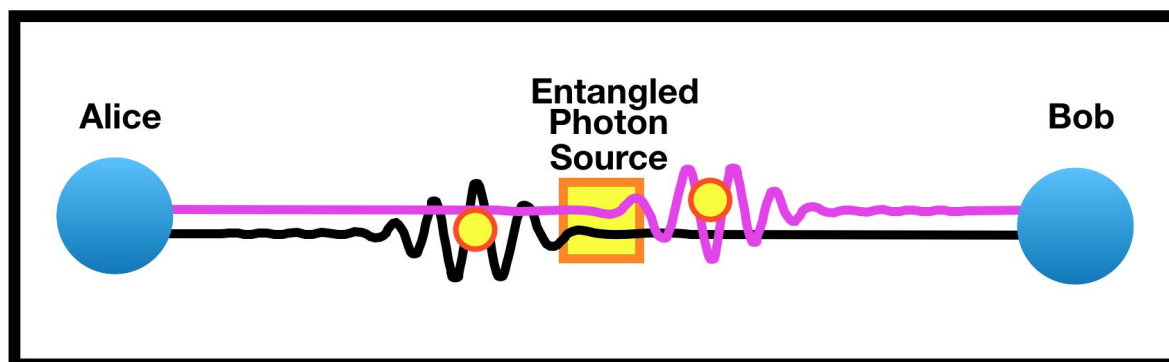

Figure 23: A Bi-Ray consists of two elementary waves traveling coaxially in opposite directions.

John Bell proposed in 1964 that Einstein's thought experiment contradicted QM. Clauser, Horne, Shimony and Holt (CHSH) designed experiments using photon polarizers that would test whether Einstein or Bell was correct. Over the next fifty years experiments proved Einstein was wrong and QM was correct, and also experiments that closed all loopholes that might allow Einstein's concept of Nature to escape the trap.

From the Bell test experiments it was allegedly "proved" that the quantum world is weird. Allegedly when Alice makes a measurement, that sends a "signal" to Bob that travels faster than the speed of light. It is an instantaneous signal, allegedly. This leads to various theories of "entanglement" that involve fanciful ideas.

Although Einstein's view of quantum reality has been defeated, that does not prove that the QM view is correct, because there are other theories which fit the Bell test experimental data. Specifically TEW is such a theory. Bell and CHSH would classify TEW as a "nonlocal" theory. It has been known for decades that nonlocal theories can explain the Bell test experiments.

As we said before, TEW implies that everywhere in Nature there are an infinite number of zero energy elementary waves traveling at the speed of light in all directions and at all frequencies. The vast majority of them are attached to no particle, and are therefore invisible to our detectors.

That implies that every elementary ray has a mate, namely an identical ray traveling coaxially in the opposite direction. This pair forms of "Bi-Ray." Two particles are **entangled** if they follow the same Bi-Ray in opposite directions. The probability of a particle following a Bi-Ray is the amplitude of it following one of the rays, times the amplitude of it following the other. Think of a railroad engine. It has an amplitude for following each of the two tracks.

What makes the countervailing rays coherent is the particle following them. It would be as if two rails were held together by a locomotive, not by the railroad ties.

The ideas stated in the last three paragraphs, which are few in number, are the **only assumptions** that are needed for the Theory of Bi-Rays to explain the Bell test experiments!

What makes TEW a "nonlocal" theory is that the same Bi-Ray stretches from Alice's equipment, through the fiberoptic cable, across the 2-photon source, through more fiberoptic cable, and into Bob's equipment. Therefore the environment inside that Bi-Ray is the same for Alice and for Bob. When a pair of entangled photons is born, it is born

into that environment. All the components of the Bi-Ray are limited by the speed of light. Nothing is transmitted instantaneously.

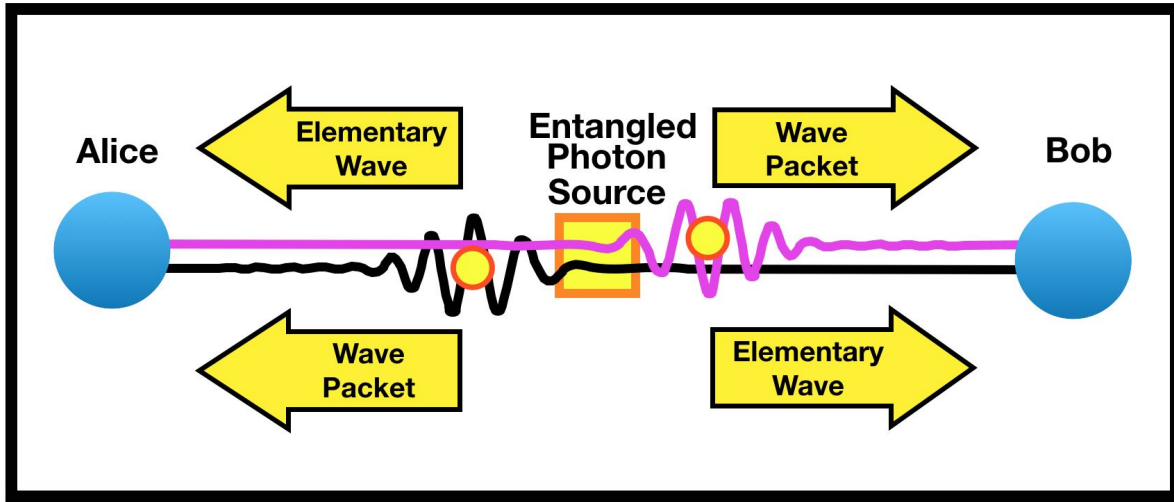

Figure 24: This is the previous Figure with yellow labels added.

7.2 Bi-Ray trigonometry

The key to understanding why Bi-Rays explain the Bell test experiments is that the two mono-rays relate to each other in complex ways. There are four eigenstates of the elementary rays individually (“V”=Vertical and “H”= Horizontal) (\vec{V} , \vec{H} , \vec{V} , \vec{H}). We use the color red to signify that a ray is moving to the right; and blue means left. Bi-Rays are more complicated than monorays and have these four Eigenstates:

- Eigenstate A $\vec{V} \vec{V}$,
- Eigenstate B $\vec{H} \vec{V}$,
- Eigenstate C $\vec{V} \vec{H}$,
- Eigenstate D $\vec{H} \vec{H}$.

Fig. 24 shows the complicated situation that exists inside a Bell test experiment. On the left is Alice who randomly sets her polarizer to angle θ_1 . On the right is Bob who randomly sets his polarizer to angle θ_2 . Between Alice and Bob is fiberoptic cable and a 2-photon-source (see yellow rectangles). The research question is, “What is the probability of Alice and Bob both seeing a photon simultaneously?”

QM asks that same question but uses the term “coincidence rate” instead of “probability.”

Fig. 24 is divided into four layers, one for each Eigenstate of the Bi-Ray. For example, the top layer consists of Eigenstate A, which we defined as: $\vec{V} \vec{V}$. What is that amplitude of a photon being visible to Alice’s equipment from the Mono-Ray moving to the left with vertical polarization? Answer: $\cos(\theta_1 - V)$. What is the amount due to the Mono-Ray moving to the right? Answer: $\cos(\theta_1 - V)$. We have previously defined the probability of a photon following the Bi-Ray is the amplitude of it following one ray times the amplitude of it following the countervailing ray, or $\cos(\theta_1 - V)$ times $\cos(\theta_1 - V)$.

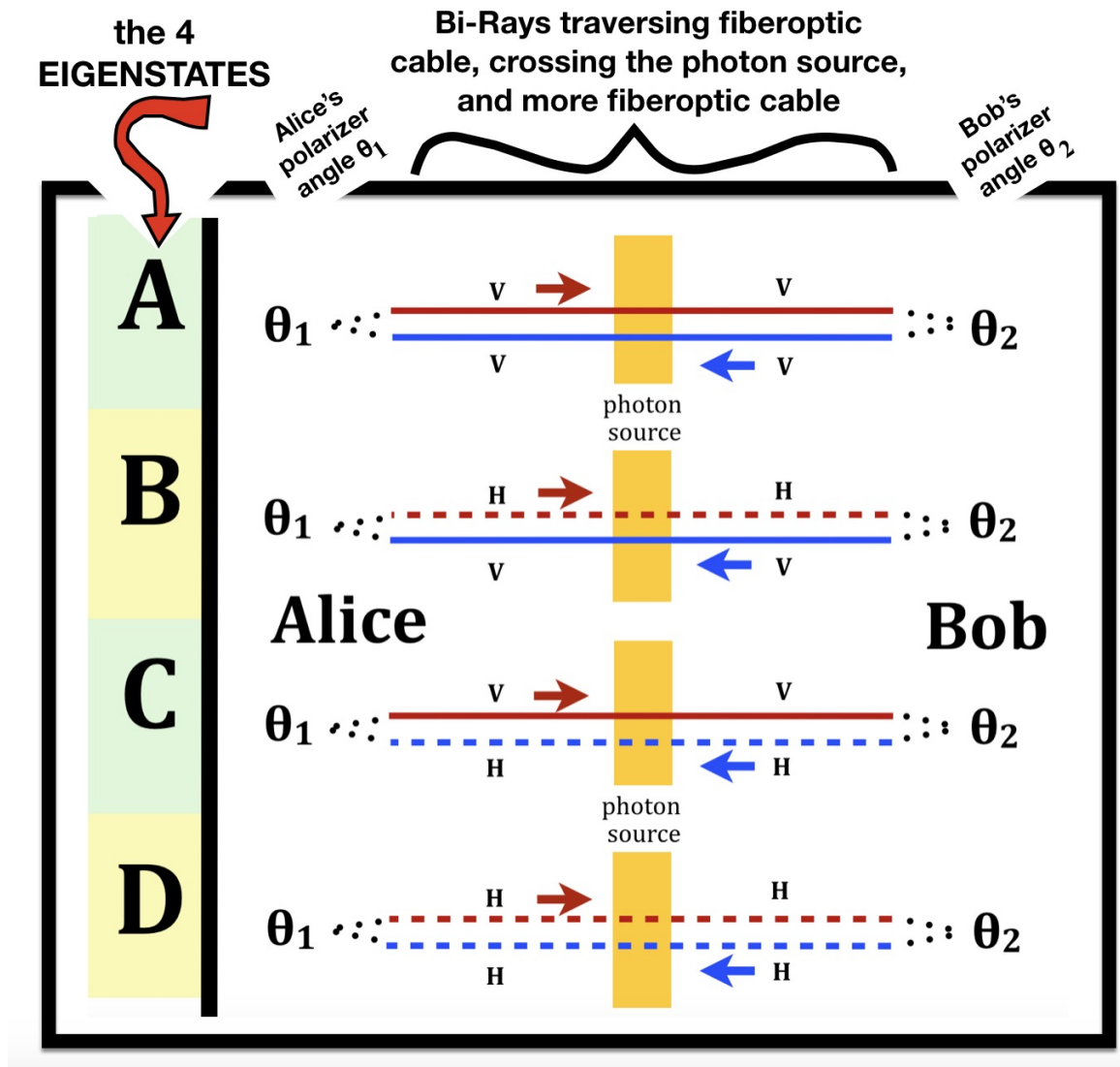

Figure 25: Alice and Bob look at incident photons through polarizers set at random angles θ_1 and θ_2 and record whether they do, or do not see a photon: YES / NO. At a later time a computer analyzes the data after coordinating the time of the two citations.

A law of probability is that the probability of Alice and Bob both seeing a photon is a product of the probability of each of them seeing a photon in Eigenstate A. Therefore the top layer of Fig. 24 will give us:

$$P = [\cos(\theta_1 - V)\cos(\theta_1 - V)] \text{ TIMES } [\cos(\theta_2 - V)\cos(\theta_2 - V)]$$

The probability of both people seeing a photon simultaneously is the sum of the probabilities in each of the four Eigenstates. When we turn the crank of the trigonometry machinery the trigonometry does the work for us. The

probability of both Alice and Bob seeing a photon simultaneously is:

$$\begin{aligned} & \text{EigenstateA} \quad [\cos(\theta_1 - V)\cos(\theta_1 - V)] \times [\cos(\theta_2 - V)\cos(\theta_2 - V)] \\ & \text{EigenstateB} + [\cos(\theta_1 - H)\cos(\theta_1 - V)] \times [\cos(\theta_2 - H)\cos(\theta_2 - V)] \\ & \text{EigenstateC} + [\cos(\theta_1 - V)\cos(\theta_1 - H)] \times [\cos(\theta_2 - V)\cos(\theta_2 - H)] \\ & \text{EigenstateD} + [\cos(\theta_1 - H)\cos(\theta_1 - H)] \times [\cos(\theta_2 - H)\cos(\theta_2 - H)] \end{aligned}$$

If we use polar coordinates, so the angle V is zero, and H is $\pi/2$, then we get:

$$\begin{aligned} P = & [\cos(\theta_1)\cos(\theta_1)] \times [\cos(\theta_2)\cos(\theta_2)] \\ & + [\sin(\theta_1)\cos(\theta_1)] \times [\sin(\theta_2)\cos(\theta_2)] \\ & + [\cos(\theta_1)\sin(\theta_1)] \times [\cos(\theta_2)\sin(\theta_2)] \\ & + [\sin(\theta_1)\sin(\theta_1)] \times [\sin(\theta_2)\sin(\theta_2)] \end{aligned}$$

which can be factored:

$$\begin{aligned} = & [\cos(\theta_1)\cos(\theta_2) + \sin(\theta_1)\sin(\theta_2)] \\ & \bullet [\cos(\theta_1)\cos(\theta_2) + \sin(\theta_1)\sin(\theta_2)] \end{aligned}$$

for which there is a trigonometry equation, which gives us:

$$= [\cos(\theta_2 - \theta_1)] \bullet [\cos(\theta_2 - \theta_1)] \quad (37)$$

$$= \cos^2(\theta_2 - \theta_1) \quad (38)$$

The result, $P = \cos^2(\theta_2 - \theta_1)$, is the probability of both Alice and Bob seeing a photon simultaneously. In the literature about Bell test experiments, this is called a ‘‘Coincidence Rate.’’ It is exactly the answer found by QM if the two photons are emitted with the same orientation.

Figs. 25 and 26 show three dimensional graphs of the equation $Z = \cos^2(\theta_2 - \theta_1)$. It looks like blue ocean waves. If Alice chooses angle θ_1 , that can be graphed as the red line undulating across the waves (Fig. 24). That leaves a full range of possible values of θ_2 for Bob to choose from. Alice’s choice does not constrain or influence Bob’s choice.

Figs. 25 and 26 show that for any value of θ_1 chosen by Alice, if Bob chooses a random angle θ_2 , then the height of the graph will give the probability that they will both simultaneously see a photon at angles θ_1 and θ_2 .

The results reported so far are based on a 2-photon source that emits photons with a correlated polarization. For example, the famous Aspect, Dalibard and Roger experiment of 1982 used a calcium-40 source that produced two photons with correlated polarization and obtained similar results as ours.[7,27]

There would be different results if the two photons were orthogonal to one another at birth. That would happen for example if the pair of photons was produced by a Wollaston prism. Then the final probability would be $Z = \sin^2(\theta_2 - \theta_1)$.

7.3 What do the Bell test experiments tell us about the quantum world?

In experiment after experiment QM has asserted that the quantum world is weird. Yet when we change to the TEW mathematics we find that the quantum world is not weird. The quantum world is very similar to the classical world of

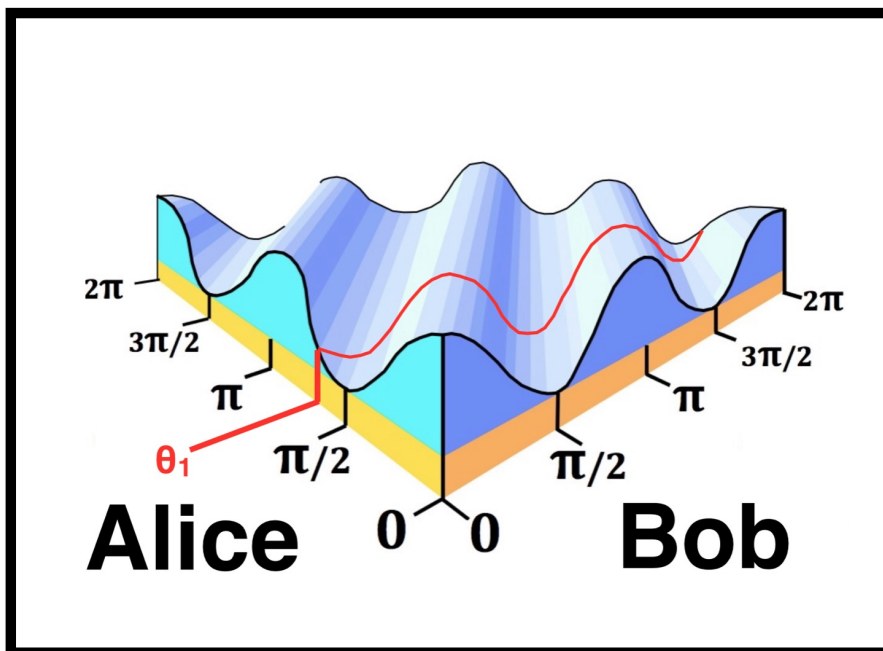

Figure 26: This graph of $Z = \cos^2(\theta_2 - \theta_1)$ has an undulating red line indicating that Alice chose angle $\theta_1 = 0.3\pi$. Bob can choose angle θ_2 at random and the height of the curve shows the probability that they each see a photon at that pair of polarizer angles.

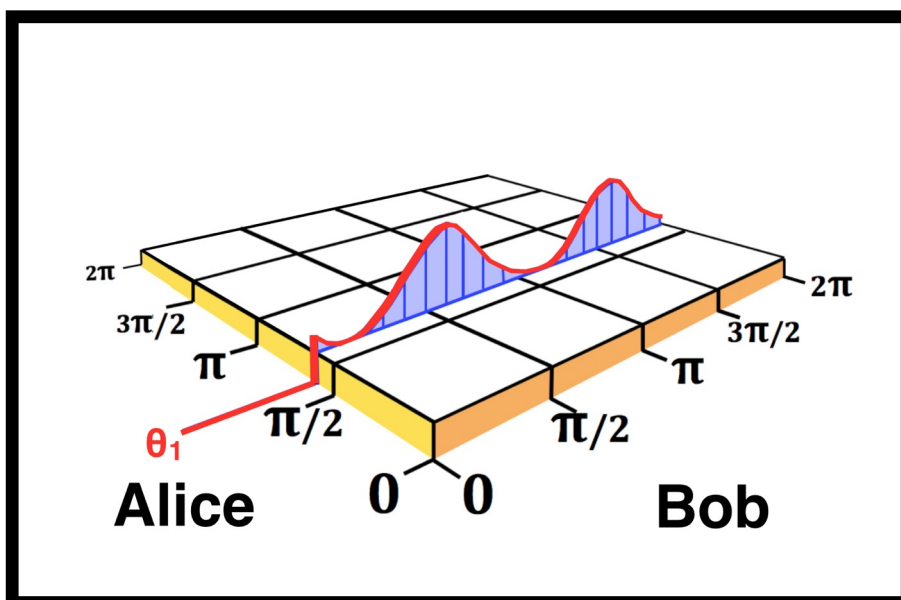

Figure 27: This is a vertical slice of exactly the same graph as above.

everyday experience.

For example, in the Bell test experiments QM asserts that wave function collapse occurs when something is measured. Thus when Alice observes her photon at angle θ_1 , that reality comes into existence. Prior to her observation that photon had no specific characteristics or attributes. When Bob observes his photon at angle θ_2 that reality also comes into existence. So how quickly would we expect there to be an equation showing that the correlation rate of Alice and Bob's observation is $\cos^2(\theta_2 - \theta_1)$?

From the viewpoint of QM it is astonishing that this result emerges instantaneously, without time for a signal from Alice's equipment to reach Bob at the speed of light. That is why they conclude that instantaneous communication has occurred. As Franco Selleri said, "With QM a lot of miracles happen!"

When we shift to the TEW mathematics, things look entirely different. The fact that the correlation rate between Alice's data and Bob's data is $P = \cos^2(\theta_2 - \theta_1)$ is what we would expect, once we know that there is a Bi-Ray stretching from Alice to Bob. Nothing else could happen, unless you change the 2-photon source. In TEW nothing travels faster than the speed of light, and wave function collapse occurs **before** you measure something. Wave function collapse happens when a pair of photons is born into that bi-ray environment instead of another bi-ray environment.

We have demonstrated in an earlier publication that TEW is able to explain quantum computers.[10]

Thus the alleged deep mysteries of the quantum world vanish if we adopt TEW technology.

8 The Purcell effect shows that quantum experts already know about elementary waves

Many experiments have established the Purcell effect, which is that an excited atom will decay more rapidly and emit a photon (to carry off the excess energy) if the excited atom is in a micro-cavity whose diameter is a multiple of $\lambda/2$ where λ is the wavelength of the photon about to be emitted.[42]

Information about the size of the cavity must be carried somehow into the excited atom, before it decays and emits a photon. Otherwise how does the atom know that it is a hospitable environment? That information enters the atom with zero energy. QM experts give this phenomenon the names "available states" or "modes of the cavity." TEW agrees and simply uses a different word. What the experts call an "available state," we call an "elementary wave."

For example, if a Rydberg atom (such as sodium, cesium, beryllium, magnesium or calcium) is heated in an oven, then a laser is used to excite the outer electron to a higher energy state, and the excited atom is put into a resonant cavity (•), the excited atom will decay hundreds of times faster and lose its excess energy (as a photon) if the width of the cavity is a multiple of the wavelength λ of the photon which the atom wants to emit. This was discovered in the 1946 by Edward Purcell.[42]

This experiment demonstrates that quantum experts are familiar with elementary waves. They simply give them a different name than we do. What we call "elementary waves" in resonant cavities, QM experts call "available states" or "modes of the cavity."

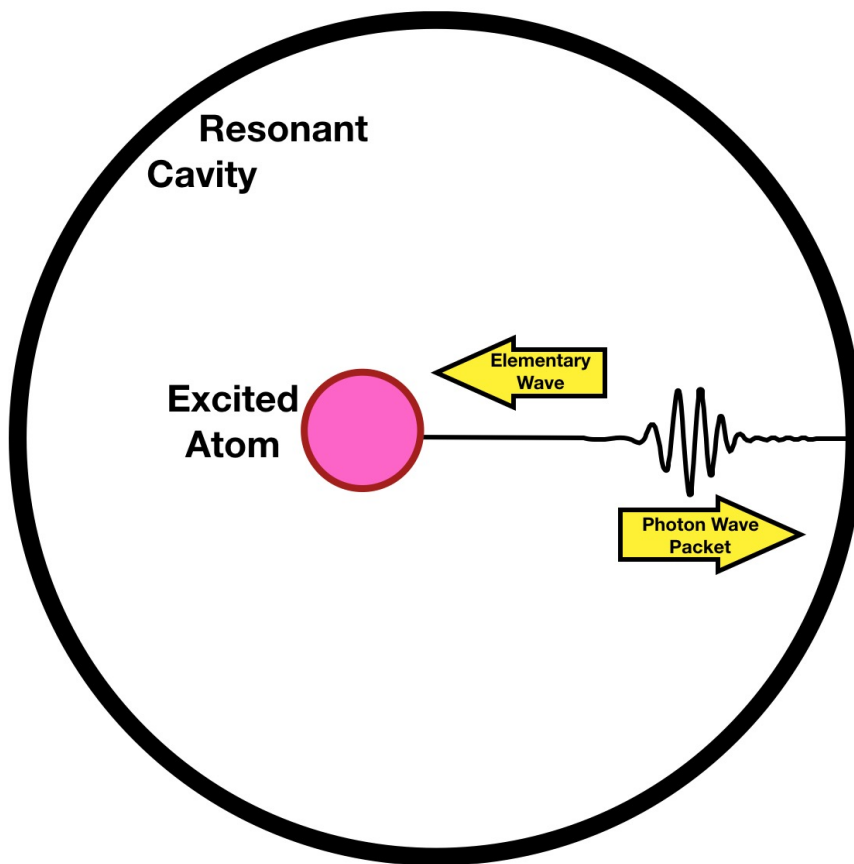

Figure 28: The elementary wave travels left carrying into the atom information about the diameter of the cavity. A photon wave packet travels in the opposite direction if the diameter is a multiple of $\lambda/2$.

9 Conclusion: Where did these ideas come from?

Einstein and dozens of other geniuses searched for the past century to try to find the solution to the quantum enigma, and didn't find it.[5,6] Yet here it is, given to you free of charge in this article. How is that possible? How did it happen?

9.1 A brief history of TEW

The ideas presented in this article evolved over five decades. That evolution did not occur at the major academic centers such as CERN, Stanford research park, the Institute of Advanced Studies, the University of Innsbruck, nor MIT. It occurred outside the horizon of mainstream science. When it peeked up from obscurity the leaders of science did not recognize it and rejected it, much as what happened to Alfred Wegener (see below)

First there was the counter-intuitive idea that particles follow zero energy waves backwards. After working alone for thirty years a physicist named Lewis E. Little discovered that idea in March 1993.

Twenty seven years later, in the year 2020, there was a refinement of that idea that emerged for the first time in the article you are now reading. Particles don't follow waves backwards. There are Schrödinger waves that represent the particle, and the Schrödinger waves travel in the expected direction. But Schrödinger wave packets are part of a larger elementary wave traveling in the opposite direction as the particle.

These two colorful people, Lewis Little and myself, are cousins who have been in dialog for 60 years. To understand where TEW came from, you need a thumbnail sketch of that relationship. Seven years ago we had a fight and are no longer speaking to each other. Here is a sketch of how TEW emerged from our turbulent relationship.

In high school Lewis Little's IQ was tested and found to be 196. He was a lot smarter, and two years older than me. We would sit on the living room floor at my grandmother's house on holidays, playing 3 dimensional tic-tack-toe (on a cube that was $4 \times 4 \times 4$). The problem with 3 dimensional tic-tack-toe is that whoever goes first can always win. So we designed and played 4 dimensional tic-tack-toe (on a $5 \times 5 \times 5 \times 5$ hypercube). The diagonals were difficult to picture. I don't remember who won.

I went to Brown University to study mathematics based on Lewis's recommendation of Brown. I think he graduated summa cum laude in physics three years before I graduated in math. When he graduated he said to me, "Either QM is crazy, or I am." I thought at the time, "Lewis, you argue with everyone about everything!" Although Little had a huge impact on my life, his love of arguing was annoying.

9.2 Why QM inflicts suffering on anyone who is logical

What did Little mean when he said that QM "was crazy"? QM is the most powerful and accurate science that humans have ever had, and is the basis of our entire high tech economy. As a mathematics it works well. But rarely can we picture what the quantum world looks like. That missing picture can be called "metaphysics." Since it is a jumble of incoherent images, each of which is out-of-focus, "metaphysics" has a bad reputation in QM. Experts say it should be avoided. David Mermin said, "Shut up and calculate!" What he meant when he said said, "Shut up" was: "Stop thinking. Stop using the non-mathematical parts of your brain! Stop using images to picture things."

What Lewis Little hated about QM was the metaphysics, or rather the lack of a metaphysics. He could not bring himself to stop thinking. "I think in images," he once said. A man whose brain was ruled by a tyranny of hyper-logic, could not tolerate a tyranny of illogicality. When he encountered QM he was able to do the math, but he began to suffer because he could not accept contradictions. Little could not accept the idea that QM had no metaphysics, nor could he tolerate the idea that the quantum world is sometimes an incoherent mishmash. He needed to solve that problem, just as Andrew Wiles could not tolerate the absence of a proof of Fermat's last theorem. Like Wiles, Little had an obsessive style of thinking and his brain had no "OFF" switch.

The classical world of everyday experience is transparent. When we open our eyes and look at anything, what we see is the quantum world, staring back at us. Little could not deny the need for a coherent picture of the quantum world. That is what he meant when he said, "Either QM is crazy, or I am."

9.3 Thirty years in isolation

Little went to graduate school at Princeton University to answer the question about whether he or QM “was crazy.” He concluded that it was QM and not he who was crazy. At the time, I thought, “Are you SURE that it is not you that is crazy? It could be BOTH!” His PhD in physics was from New York University in 1974.

Many people with a PhD in physics end up in Wall Street, investing in the stock market. Little developed a career trading in commodities. That was his daytime job. Nights and weekends were devoted to his passion, which was to rethink QM so as to discover a theory without weirdness.

He read physics and drilled down in QM for thirty years, working in isolation, talking to no one. Aristotle’s thinking was one of his guides. Little told me that his notebooks show a pattern: every five years he would cover about the same territory, without any progress. He went around in circles six times. “I kept making the same mistake Einstein made, which was to believe in wave particle duality,” he said.

After thirty years working alone he had the peculiar thought in 1993 that, “Could it be that the wave is traveling in the opposite direction as the particle?” That was a “Eureka!” moment, when all the pieces of the puzzle fell into place. It was the happiest day of his life. He believed that he had triumphed, that he would now become a professor of physics, fabulously wealthy and famous. Unfortunately that did not happen.

When he sent a scholarly paper to leading physics journals, he expected that he would be applauded. That did not happen. His manuscript was repeatedly rejected. Journals would send it back without peer review, perhaps with “This isn’t science” written on the front page, or with no comment other than, “Not appropriate for this journal.” After years of universal rejection it was finally published in *Physics Essays* in 1996,[37] and he was invited to give a talk at the Jet Propulsion Labs at CalTech.[38] It seemed promising at first. But then interest in TEW petered out.

I first heard about TEW in the year 2000 at a birthday party at Lewis Little’s house. My aunt Marge (his step mother) was 80 years old. TEW sounded like a fascinating idea. I couldn’t understand it. He said, “It is a local theory.” I had no idea what he meant by “local,” nor did I have the faintest idea why that was important. At that time it sounded to me like “How many angels can dance on the head of a pin?”

Physicists continued to turn a deaf ear towards TEW. Over the years Little became angry, and in 2009 he published a book, *Theory of Elementary Waves*, the first paragraph of which was a scathing attack on physicists. Here is the first sentence: “The science of physics, as conceived by today’s leading academic theoreticians, has become insane to the point of farce.”[39]

The introduction to that book was a disaster, from my point of view. You cannot attack the very audience whose support you need if your theory is to succeed. I had published a lot in the medical sciences.[28-30] I didn’t understand much about TEW, but I thought (erroneously) that I understood how new ideas get disseminated.

I got involved in trying to market TEW to physicists. Unlike Little, I had no academic qualifications in physics. I joined the American Physical Society (APS) and got Little to join also. In 2010 I began presenting TEW to physicists, which took courage. I continued for the next nine years to present TEW at APS conventions, up to four times a year. At the beginning I dragged Little along to support me and answer questions. In 2012 I began publishing articles on TEW in peer reviewed physics journals. I reviewed several “delayed choice” quantum experiments and showed that they could be explained by TEW without quantum weirdness.[25-27]



Figure 29: Lewis E. Little and me in 2011. We are cousins.

TEW had almost no mathematics at that time. Little would puzzle over the Dirac equation for weeks, frustrated that he couldn't see how it related to TEW. He assigned me the task of developing a mathematics, since I was the one with a degree in math. His primary interest was the metaphysics of TEW. Ayn Rand had defined metaphysics as the starting point for science. I told him he should avoid metaphysics, which physicists say they hate. Metaphysics was Little's central focus. For example, he insisted that TEW portrays the quantum world as "local." He hated the "nonlocal" doctrine of QM. Hated it!

For many years I could not figure out any math, and felt stupid. Reading the history of mathematics helped me see that all new math emerges from bewilderment and turbulent chaos. For years I believed that I was incapable of concocting a mathematics for TEW. After all, I was over the age of thirty and I erroneously believed no one over thirty comes up with any new math. In the end, I was astonished at what emerged from this rusty old brain!

9.4 Isaac Newton was a quarrelsome man

Over the sixty years I have known him, Little was one of the more argumentative people I ever met. That is both a strength and a weakness. He once bickered with me for more than an hour about why I refused to bicker with him. "I don't think it would be useful," I said. He enjoyed bickering. I didn't. He could out-think me in an argument. "Why would I want to argue when you win every argument?," I asked.

Isaac Newton was also quarrelsome. Had Newton been otherwise, he probably would not have accomplished what he

did. Can you imagine how history would change if Newton had been an agreeable fellow and we had no *Principia Mathematica*?

Eventually Little resigned from the APS because he thought they were perverting science with their ideas about global warming. He told me there was no evidence of global warming. It was an anti-capitalist conspiracy, he said. I completely disagreed. I thought global warming was the greatest disaster humans have ever faced. But I knew for certain that if I bickered with him about that, I would not change his opinion, nor would he change mine. He was a follower of Ayn Rand (a contentious author) and extremely pro-capitalist.

My wife warned me for years, “Your friendship with him is not going to last. Someday it will blow up.” As usual, she proved to be correct.

Professor Stephen Speicher of Caltech was the leading spokesman of TEW.[44-45] Speicher was also an Ayn Rand enthusiast, as were all of the early supporters of TEW, except me. Speicher told me that the pivotal issue was whether or not TEW could explain the Bell test experiments. If TEW could do that, would it become popular among physicists.

Little and I had many conversations about the Bell test experiments. We discussed bi-waves for years. Speicher meanwhile died. It was the biggest disaster that ever struck TEW, leaving us with no spokesman. There was no one who could bring TEW to the scholarly community that matters.

For years Little and I argued about publishing this idea about bi-waves. My position was that if Speicher said this was THE pivotal issue, then we had to publish as quickly as possible, for the sake of science and the human race, who would benefit from TEW. Little’s view was that he didn’t want to publish something that until he had thought it through from every possible angle. He was not sufficiently sure that the theory of bi-waves was true.

Little spoke of becoming wealthy because of TEW. I told him that TEW had yet to prove that it was worth three pennies. I thought TEW belonged to the human race. It was not Little’s private property. It was easy for me to imagine my worst fear: that we would die of old age and TEW would vanish from the earth. Eventually, out of frustration, I told him that if he didn’t publish the ideas about bi-waves in two years, I would. I don’t think he took me seriously. I said it more than once.

More than two years passed with no hint of a manuscript from Little. So I wrote up the bi-wave theory, giving all the credit to Little, and submitted it to *Physics Essays* where it was published in 2013.[27] That ruptured and ended our relationship, as you are about to read.

9.5 Public Domain versus Proprietary Intellectual Property

There was a difference between me and Little that made a divorce inevitable. Within the world of research and new technology there are two warring schools of thought. There are those who believe new research should be in the public domain with open source code. Mathematicians tend to think that way. The other viewpoint is proprietary. When people develop new technology, they want a return on their investment. Who should own intellectual property? I was committed to the public domain. Little was committed to private property and capitalism. I don’t remember him ever saying anything positive about the public domain.

The history of computers is helpful to remember. When general purpose computers were first invented in the mid-1940's, John von Neumann was a central figure who was committed to the public domain. ENIAC was the first general purpose computer, designed by John Mauchly and J. Presper Eckert. Computer programming was invented by women such as Jean Jennings.

Von Neumann was a gregarious mathematician, trained by Hilbert. Von Neumann needed a computer to help design atomic bombs and hydrogen bombs. He was trying to encourage fertile ideas when he circulated a hand written 100 page memorandum in 1945 summarizing the creative thinking of many people. He wrote it on long train rides. The manuscript had blank spaces where he wanted other people to write their ideas.

The army funded computer development. Lieutenant Herman Goldstine controlled the purse strings. He was an army officer committed to the public domain. Without asking anyone, Goldstine published von Neumann's essay under the title "First Draft of a Report on the EDVAC by John von Neumann."

For decades that book was the most important source of information about computers. That report put all those ideas in the public domain. Eckert, Mauchly and Jennings were horrified. They said that much of that information was proprietary and belonged to them. Lawsuits went on for years. A lot of money was at stake. Computer technology was a goldmine. Eventually the courts decided that von Neumann's book put all the information in the public domain.[35]

Von Neumann said, with disdain, "Eckert and Mauchley are a commercial group with a commercial patent policy. We cannot work with them directly or indirectly in the same open manner in which we would work with an academic group." [35]

The vast cultural divide between public domain and proprietary information afflicts all technological research today. For example, Apple and Google are now spending more money per year on lawsuits to protect their proprietary information, than they are spending on research to develop new technology. The advantage of treating new ideas as proprietary is that it attracts and protects investors who want to pay for the development of new ideas (such as quantum computers) only if there is a large return on investment. The advantage of being wide open like *Journal of Advances in Mathematics*, is that it provides a forum for ideas that are so innovative that the mainstream journals are afraid to touch them.

9.6 TEW confronts the Public Domain versus Proprietary Intellectual Property debate

Inevitably Lewis Little and I had a bitter argument in 2013, when I published the idea of bi-waves to explain the Bell test experiments.[27] Although I gave Little the credit for discovering bi-waves, nevertheless he was enraged that I would publish such a thing without his permission. He had taken no legal steps to establish TEW as his private intellectual property. In fact he had done the opposite. When I presented TEW at dozens of APS conventions, and when I submitted manuscripts that were published in physics journals, he generously supported me and offered good advice.

When I published a TEW solution to the Bell test experiments, Little said that unless I prevented *Physics Essays* from publishing the manuscript next week, he would contact a lawyer this afternoon and sue me for every penny I was worth. Part of what horrified him was that I said that TEW was a "nonlocal" theory, which he said was a betrayal. He

implied I had joined his enemies. He suspected that my goal was to destroy TEW. For me it was a painful and intimidating argument. He told me our friendship was ended and that we would never speak again. It has now been seven years with no communication.

No lawsuit ever materialized. The difference between TEW and computer science was that computer science was a goldmine. Lawyers are not interested in ideas that are not lucrative. Furthermore, Little and I live in different jurisdictions.

My view is that the words “local” and “nonlocal” have different meanings to different people. I claim that TEW can be said to be either, depending on what you mean by those words (see Section 8). Mostly I think those words are meaningless if you move outside the debate between QM and Einstein.

It was never my intention to “steal TEW” from Little. What motivated my many YouTube videos and scholarly articles in peer reviewed journals was the need to market TEW. The blunt fact was: Stephen Speicher was dead and TEW had NO spokes person. The idea that TEW was so brilliant and so unknown drove me crazy. **See my website at ElementaryWave.com.**

Meanwhile the impact of my telling the physics community that TEW could explain the Bell test experiments was zero. Speicher was wrong. That was not the obstacle that was preventing physicists from becoming interested in TEW.

I have been no more successful than Little in getting scientists to think about TEW. At a party at our house yesterday, David, a mathematician friend of mine, told me, “I watched your latest YouTube video. I see you have not yet recanted. I don’t know what motivates you to keep knocking your head against a brick wall. I don’t think a century from now anyone will be interested in TEW.”

In retrospect I feel about Lewis Little the same way the Chinese must have felt when they first saw a new star appear in 1054, so bright that it was visible in the daytime. It was brighter than all the other stars combined. That supernova explosion created the Crab Nebula. When I speak to my friends about Lewis Little or that 1054 explosion, most of my friends don’t know what I am talking about. Nor do they care. My friends think, “Jeff Boyd is passionate about some obscure crap! He is an odd duck. I like Boyd, but I don’t understand half of what he says.” Meanwhile I am obsessed by the jets of plasma shooting out perpendicular to the Crab Nebula neutron star’s plane of rotation.

9.7 Who is afraid of preposterous ideas, and who isn’t

It may be that the scientific community will never grow interested in TEW. Physicists sometimes take me aside and encourage me, saying that no one else can explain these things that TEW can explain. “Don’t give up,” they tell me, “No one else can explain the double slit experiment, but you can!” These encouraging physicists are timid and afraid of ruining their reputation. No physicists want their name associated with this heresy.

I am convinced that TEW is correct. The greatest disaster I can imagine is when our generation dies of old age, if TEW peters out and vanishes from the face of the earth. It is an idea that might not enter human history again. I owe it to my grandchildren for their generation to have an opportunity to hear about this idea. So I awaken at 4 AM day after day, because 4 AM is when my brain is able to think about the unthinkable, and imagine the unimaginable. Sometimes I am lazy and sleep in until 5 AM.

My wife encourages me in this insanity. Why? “It will prevent cognitive decline,” she says. Furthermore our marriage is based on each of us encouraging the other one to be who we really are.

In the year 2020 it occurred to me that it was a mistake to say that particles follow elementary waves backwards. There is a mountain of data saying that particles and Schrödinger wave packets travel in the same direction. This led me to recognize that the apparent contradictions of the quantum world might be embedded in the structure of quantum waves, namely that they travel in opposite directions simultaneously.

I now think Little’s insight of 1993 half wrong, and half right. There must be some compromise, some middle ground between TEW and QM. My personal style is one of seeking compromises. Whereas Little prefers “Either-Or,” I prefer “Both-And”

It dawned on me that **elementary waves and Schrödinger waves are two aspects of the same thing**. In ancient Rome there was a god named Janus who had two faces (Fig. 30). He/she was the god of doorways, gates, passages, transitions, beginnings and endings, time and duality. He/she was like an elementary wave.



Figure 30: Janus was a god of ancient Rome, facing in two directions simultaneously. This is similar to how elementary waves and Schrödinger waves are two aspects of the same thing.

Mathematicians live in a world where “bizarre” is an advantage for a new idea. Do mathematicians ever stumble across

new ideas that are not “bizarre”? The Taniyama-Shimura-Weil conjecture was bizarre: that there was a relationship between modularity and elliptical curves. Andrew Weil’s proof of Fermat’s last theorem using deformation theory in Galois representations was bizarre. Bernhard Riemann’s geometry was so bizarre that other mathematicians, such as Arthur Cayley rejected it as useless, declaring Euclid’s was the only geometry that made sense. A century later Albert Einstein based his general theory of relativity on Riemann.

For me TEW is a clever new idea that explains a mountain of empirical data, and allows us to see that the quantum world is not “weird.” As I said before, the quantum world cannot be “weird” because when you open your eyes and see the world of everyday experience, which is transparent, what you are seeing is the quantum world, which is right there, staring back at you.

9.8 Plate tectonics compared to TEW

TEW doubled the size of the universe we live in. To the half of Nature that consists of matter and energy, it added the other half that contains neither matter nor energy.

Franco Selleri (1936 - 2013) said that history has demonstrated that in science the majority opinion is usually wrong. When someone proposes a preposterous idea, scientists promptly reject the idea.[34]

That is what happened to Alfred Wegener’s idea in 1912.[46] He was the first person to ever propose that there had been a continent that he named “Pangea”, composed of all the continents. When Pangea split apart the pieces drifted to their present locations. Every reasonable scientist on earth denounced this idea as stupid because there was no force strong enough to move continents across the face of the earth. No map of the seabed existed in 1912. They had no idea there was a mid-Atlantic mountain range. They didn’t know that the Indian ocean floor tells us that India moved north from Madagascar and slammed into Siberia, causing the Himalayan mountains to rise. Wegener’s ridiculous idea was banned from science for half a century. Then it came back in the form of plate tectonics and has dominated geology ever since.

So you never know. Perhaps my friend David was wrong and a century from now scientists will be interested in TEW. It is clear that I will not see it during my lifetime. After my 76th birthday it dawned on me that possibly I might not be immortal. That is a startling new thought.

Acknowledgment:

The author thanks Lewis E. Little who taught him the Theory of Elementary Waves, and challenged this author to develop a corresponding mathematics.

Author Biography:

The author was raised in the family of a factory worker in New Jersey, USA. He is the first member of his family to graduate from college. In elementary school he and his family were astonished to discover that he had a talent in mathematics. He subsequently graduated with advanced degrees from Harvard, Yale, Brown and Case Western Reserve Universities, and spent a decade on the faculty of the National Institutes of Health in Bethesda, Maryland. He was ordained a priest in the Episcopal Church. He also served as Chairman of Psychiatry at Waterbury Hospital in CT. His passion was treating indigent patients with severe chronic illnesses. He is now retired. Other aspects of his

biography can be found in the “10. Conclusion,” (above) in this article.

References

- [1] Adams, A. (2013) 8.04 Quantum Mechanics - 1 (Massachusetts Institute of Technology), videos available at <https://ocw.mit.edu/courses/physics>, access date June 17, 2017.
- [2] Aspect, A., P. Grangier, and G. Roger. (1981) Experimental tests of realistic local theories via Bell's theorem. *Physical Review Letters*, 47, 460-463. <https://doi.org/10.1103/PhysRevLett.47.460>
- [3] Aspect, A., P. Grangier, and G. Roger. (1982) Experimental realization of Einstein-Podolsky-Rosen-Bohm Gedankenexperiment. *Physical Review Letters*, 49, 91-94. <https://doi.org/10.1103/PhysRevLett.49.91>
- [4] Aspect, A., J. Dalibard, and G. Roger. (1982) Experimental test of Bell's inequalities using time-varying analyzers. *Physical Review Letters*, 49, 1804-1807. <https://doi.org/10.1103/PhysRevLett.49.1804>
- [5] Baggott, J. (2011) *The Quantum Story: a history in 40 moments*, Oxford University Press.
- [6] Becker, A. (2018) *What Is Real?* (Basic Books).
- [7] Bell, J. S. (1964) On the Einstein Podolsky Rosen paradox. *Physics* 1, 195-200. <https://doi.org/10.1103/PhysicsPhysiqueFizika.1.195>
- [8] Boyd, J. H. (2019) Decrypting the central mystery of quantum mathematics: Part 1. New axioms explain the double slit experiment. *Journal of Advances in Mathematics* 17, 255-282. <https://doi.org/10.24297/jam.v17i0.8475>
- [9] Boyd, J. H. (2019) Decrypting the Central Mystery of Quantum Mathematics: Part 2. A mountain of empirical data supports TEW. *Journal of Advances in Mathematics* 17, 283-314. <https://doi.org/10.24297/jam.v17i0.8489>
- [10] Boyd, J. H. (2019) Decrypting the central mystery of quantum mathematics: Part 3. A non-Einstein, non-QM view of Bell test experiments. *Journal of Advances in Mathematics* 17, 315-331. <https://doi.org/10.24297/jam.v17i0.8490>
- [11] Boyd, J. H. (2019) Decrypting the central mystery of quantum mathematics: Part 4. In what medium do Elementary Waves travel? *Journal of Advances in Mathematics* 17, 332-351. <https://doi.org/10.24297/jam.v17i0.8491>
- [12] Boyd, J. H. (2020) A mathematical explanation for the double slit experiment of quantum mechanics. YouTube video (1 hour 38 min).
- [13] Boyd, J. H. (2017) A symmetry hidden at the center of quantum mathematics causes a disconnect between quantum math and quantum mechanics. *Journal of Advances in Mathematics*, 13, 7379-86. DOI: 10.24297/jam.v13i4.6413.
- [14] Boyd, J. H. (2015) A paradigm shift in mathematical physics, Part 4: Quantum computers and the local realism of all 4 Bell states. *Journal of Advances in Mathematics*, 11, 5476-5493. <https://doi.org/10.24297/jam.v11i7.1224>.

- [15] Boyd, J. H. (2015) A paradigm shift in mathematical physics, Part 3: A mirror image of Feynman's quantum electrodynamics (QED). *Journal of Advances in Mathematics*, 11, 3977-3991.
<http://cirworld.com/journals/index.php/jam/article/view/4963>.
- [16] Boyd, J. H. (2015) A paradigm shift in mathematical physics, Part 2: A new local realism explains Bell test & other experiments. *Journal of Advances in Mathematics*, 10, 3828-3839.
<http://cirworld.com/journals/index.php/jam/article/view/4806>.
- [17] Boyd, J. H. (2015) A paradigm shift in mathematical physics, Part 1: The Theory of Elementary Waves (TEW). *Journal of Advances in Mathematics* 10, 3828-3839.
<http://cirworld.com/journals/index.php/jam/article/view/4719>.
- [18] Boyd, J. H. (2018) The von Neumann and double slit paradoxes lead to a new Schrödinger wave mathematics. *Journal of Advances in Physics* 14, 5812-5834. <https://doi.org/10.24297/jap.v14i3.7820>
- [19] Boyd, J. H. (2018) The quantum world is astonishingly similar to our world: The timing of wave function collapse according to the Theory of Elementary Waves. *Journal of Advances in Physics* 14, 5598-5610. DOI: 10.24297/jap.v14i2.7555
- [20] Boyd, J. H. (2017) Paul Dirac's view of the Theory of Elementary Waves. *Journal of Advances in Physics* 13, 4731-4734. DOI: <https://doi.org/10.24297/jap.v13i3.5921>
- [21] Boyd, J. H. (2015) The Theory of Elementary Waves eliminates Wave Particle Duality. *Journal of Advances in Physics* 7, 1916-1922. <https://doi.org/10.24297/jap.v7i3.1576>
- [22] Boyd, J. H. (2015) A new variety of local realism explains a Bell test experiment: the Theory of Elementary Waves (TEW) with no hidden variables'. *Journal of Advances in Physics* 8, 2051-58.
<https://doi.org/10.24297/jap.v8i1.1541>
- [23] Boyd, J. H. (2015) A proposed physical analog of a quantum amplitude: Corkscrew model from the Theory of Elementary Waves (TEW). *Journal of Advances in Physics* 10, 2774-2783. <https://doi.org/10.24297/jap.v10i3.1324>
- [24] Boyd, J. H. (2017) The Boyd Conjecture. *Journal of Advances in Physics* 13, 4830-37.
<https://doi.org/10.24297/jap.v13i4.6038>
- [25] Boyd, J. H. (2012) Rethinking a Wheeler delayed choice gedanken experiment. *Physics Essays* 25, 390-396.
<https://doi.org/10.4006/0836-1398-25.3.390>
- [26] Boyd, J. H. (2013) Re-thinking a delayed choice quantum eraser experiment: a simple baseball model. *Physics Essays*, 26, 100-109. DOI: 10.4006/0836-1398-26.1.100.
- [27] Boyd, J. H. (2013) Re-thinking Alain Aspect's 1982 Bell test experiment with delayed choice. *Physics Essays*, 26, 582-591. <https://doi.org/10.4006/0836-1398-26.4.582>
- [28] Boyd, J. H. (1983) The increasing rate of suicide by firearms. *New England Journal of Medicine* 308, 872-74.
<https://doi.org/10.1056/NEJM198304143081504>
- [29] Boyd, J. H., J. D. Burke, E. Gruenberg, et. al. (1984) The exclusion criteria of DSM III: a study of the co-occurrence of hierarchy-free syndromes. *Archives of General Psychiatry* 41 983-89.
<https://doi.org/10.1001/archpsyc.1984.01790210065008>

- [30] Boyd, J. H. (2008) Have we found the Holy Grail? Theory of Mind as a unifying construct. *Journal of Religion and Health*, 47, 366-385. <https://doi.org/10.1007/s10943-008-9169-y>
- [31] Clauser, J. F., M. A. Horne, A. Shimony and R. A. Holt. (1969) Proposed experiment to test local hidden-variable theories. *Physical Review Letters* 23, 880-884. <https://doi.org/10.1103/PhysRevLett.23.880>
- [32] Eagle, B. (2012) DrPhysicsA 1. Schrodinger Equation, and 2. Wave Function. YouTube videos. Playlist available at: www.bobeagle.co.uk/drphysicsa.html. See also <http://www.bobeagle.co.uk/bob96.html>.
- [33] Einstein, A., B. Podolsky, and N. Rosen. (1935) Can quantum-mechanical description of physical reality be considered complete? *Physical Review*, 47, 777-780. <https://doi.org/10.1103/PhysRev.47.777>
- [34] Freire, O. (2003) Interview with Dr. Franco Selleri. *American Institute of Physics: Oral History Interviews*. <https://www.aip.org/history-programs/niels-bohr-library/oral-histories/28003-1>. and <https://www.aip.org/history-programs/niels-bohr-library/oral-histories/28003-2>. (accessed July 15, 2019)
- [35] Isaacson, W. (2014) *The Innovators: How a group of hackers, geniuses and geeks created the digital revolution*. (New York: Simon and Schuster).
- [36] Kim, Y., R. Yu, S.P. Kulik, Y.H. Shih, Marlan O. Scully. (2000) A delayed choice quantum eraser. *Physical Review Letters* 84, 1-5. DOI: 10.1103/PhysRevLett.84.1
- [37] Little, L. E. (1996) Theory of Elementary Waves. *Physics Essays* 9, 100-134. <https://doi.org/10.4006/1.3029212>
- [38] Little, L. E. (2000) Theory of Elementary Waves. Lecture at the Jet Propulsion Labs. Go to YouTube and search for "Lewis E. Little JPL" (access date Feb 17, 2020).
- [39] Little, L. E. (2009) *Theory of Elementary Waves*. New Classics Library, New York.
- [40] Pfleegor, R. L. and L. Mandel. (1967) Interference of independent photon beams. *Physical Review*, 159,1084-1088. <https://doi.org/10.1103/PhysRev.159.1084>
- [41] Pfleegor, R. L. and L. Mandel. (1968) Further experiments on interference of independent photon beams at low light levels. *Journal of the Optical Society of America*, 58, 946-950. <https://doi.org/10.1364/JOSA.58.000946>
- [42] Purcell, E. M. (1946) Spontaneous emission probabilities at radio frequencies *Physical Review*, 69, 681.
- [43] Scully, M. O. and K. Drühl. (1982) Quantum eraser: A proposed photon correlation experiment and 'delayed choice' in quantum mechanics. *Physical Review A*, 25, 2208-2213. <https://doi.org/10.1103/PhysRevA.25.2208>
- [44] Speicher, B. (2007) Obituary of Stephen Speicher (1939-2007) on the Forum for Ayn Rand fans <http://forums.4aynrandfans.com/>. (accessed Dec. 28, 2019)
- [45] Speicher, S., (1998) Theory of Elementary Waves, Stephen Speicher's Website, California Institute of Technology <http://www.speicher.com/tew.html> (accessed Dec. 28, 2019).
- [46] Wegener, A. (1966) *The Origin of Continents and Oceans*, translated by John Biram, New York, Dover Publications Inc.1966.